

NPort 5400 Series User's Manual

Ninth Edition, May 2009

www.moxa.com/product

MOXA®

© 2008 Moxa Inc., All rights reserved.
Reproduction without permission is prohibited.

NPort 5400 Series User's Manual

The software described in this manual is furnished under a license agreement and may be used only in accordance with the terms of that agreement.

Copyright Notice

Copyright © 2008 Moxa Inc.
All rights reserved.
Reproduction without permission is prohibited.

Trademarks

MOXA is a registered trademark of Moxa Inc.
All other trademarks or registered marks in this manual belong to their respective manufacturers.

Disclaimer

Information in this document is subject to change without notice and does not represent a commitment on the part of Moxa.

Moxa provides this document “as is,” without warranty of any kind, either expressed or implied, including, but not limited to, its particular purpose. Moxa reserves the right to make improvements and/or changes to this manual, or to the products and/or the programs described in this manual, at any time.

Information provided in this manual is intended to be accurate and reliable. However, Moxa assumes no responsibility for its use, or for any infringements on the rights of third parties that may result from its use.

This product might include unintentional technical or typographical errors. Changes are periodically made to the information herein to correct such errors, and these changes are incorporated into new editions of the publication.

Technical Support Contact Information

www.moxa.com/support

Moxa Americas:

Toll-free: 1-888-669-2872
Tel: +1-714-528-6777
Fax: +1-714-528-6778

Moxa China (Shanghai office):

Toll-free: 800-820-5036
Tel: +86-21-5258-9955
Fax: +86-10-6872-3958

Moxa Europe:

Tel: +49-89-3 70 03 99-0
Fax: +49-89-3 70 03 99-99

Moxa Asia-Pacific:

Tel: +886-2-8919-1230
Fax: +886-2-8919-1231

Table of Contents

| | | |
|------------------|--|------------|
| Chapter 1 | Introduction..... | 1-1 |
| | Overview | 1-2 |
| | Package Checklist | 1-2 |
| | Product Features..... | 1-3 |
| | Product Specifications..... | 1-3 |
| Chapter 2 | Getting Started..... | 2-1 |
| | Panel Layout..... | 2-2 |
| | Connecting the Hardware..... | 2-4 |
| | Wiring Requirements | 2-4 |
| | Connecting the Power | 2-4 |
| | Grounding the NPort 5400 | 2-4 |
| | Connecting to the Network | 2-5 |
| | Connecting to a Serial Device..... | 2-5 |
| | LED Indicators..... | 2-5 |
| | Adjustable Pull High/low Resistors for the RS-485 Port | 2-6 |
| Chapter 3 | Initial IP Address Configuration..... | 3-1 |
| | Initializing the NPort's IP Address | 3-2 |
| | Factory Default IP Address | 3-2 |
| | LCM Display (No support in NPort 5450-T/5450I-T) | 3-2 |
| | NPort Administration Suite | 3-5 |
| | ARP | 3-5 |
| | Telnet Console..... | 3-6 |
| Chapter 4 | Choosing the Proper Operation Mode..... | 4-1 |
| | Overview | 4-2 |
| | Real COM Mode | 4-2 |
| | TCP Server Mode..... | 4-3 |
| | TCP Client Mode..... | 4-4 |
| | UDP Mode..... | 4-4 |
| | Pair Connection Mode..... | 4-4 |
| | Reverse Telnet Mode..... | 4-5 |
| | Disabled Mode | 4-5 |
| Chapter 5 | Web Console Configuration | 5-1 |
| | Opening Your Browser..... | 5-2 |
| | Basic Settings | 5-4 |
| | Network Settings | 5-6 |
| | Serial Settings..... | 5-10 |
| | Operating Settings..... | 5-12 |
| | Real COM Mode..... | 5-12 |
| | TCP Server Mode | 5-15 |
| | TCP Client Mode | 5-19 |
| | UDP Mode | 5-23 |
| | Pair Connection Mode | 5-26 |
| | Reverse Telnet Mode | 5-27 |
| | Disabled Mode | 5-28 |
| | Accessible IP Settings | 5-29 |

| | | |
|-------------------|--|------------|
| | Auto Warning Settings | 5-30 |
| | Auto warning: E-mail and SNMP trap..... | 5-30 |
| | Event Type..... | 5-31 |
| | Monitor..... | 5-33 |
| | Monitor Line | 5-33 |
| | Monitor Async | 5-33 |
| | Monitor Async-Settings..... | 5-33 |
| | Change Password | 5-34 |
| | Load Factory Default | 5-34 |
| Chapter 6 | Configuring NPort Administrator..... | 6-1 |
| | Overview | 6-2 |
| | Installing NPort Administrator | 6-2 |
| | Configuration | 6-4 |
| | Broadcast Search..... | 6-5 |
| | Specify by IP Address..... | 6-6 |
| | Password Protection | 6-6 |
| | Unlock Password Protection | 6-7 |
| | Configuring the NPort 5400..... | 6-8 |
| | Web Console..... | 6-10 |
| | Upgrading the Firmware | 6-10 |
| | Export Configuration | 6-11 |
| | Import Configuration | 6-12 |
| | Monitor..... | 6-13 |
| | Port Monitor | 6-19 |
| | COM Mapping | 6-20 |
| | On-line COM Mapping..... | 6-21 |
| | Off-line COM Mapping | 6-26 |
| | IP Address Report..... | 6-28 |
| | Automatic Message Log..... | 6-29 |
| Chapter 7 | NPort CE Driver Manager for Windows CE | 7-1 |
| | Overview | 7-2 |
| | Installing NPort CE Driver Manager..... | 7-2 |
| | Using NPort CE Driver Manager | 7-2 |
| Chapter 8 | IP Serial LIB..... | 8-1 |
| | Overview | 8-2 |
| | IP Serial LIB Function Groups..... | 8-3 |
| | Example Program..... | 8-3 |
| Appendix A | Pinouts and Cable Wiring | A-1 |
| | Port Pinout Diagrams | A-2 |
| | Ethernet Port Pinouts | A-2 |
| | Serial Port Pinouts..... | A-2 |
| | Cable Wiring Diagrams | A-3 |
| | Ethernet Cables | A-3 |
| | Serial Cables | A-3 |
| Appendix B | Well Known Port Numbers | B-1 |
| Appendix C | SNMP Agents with MIB II & RS-232 Like Group | C-1 |
| Appendix D | Auto IP Report Protocol..... | D-1 |

Appendix E Compliance Notice E-1

1

Introduction

Welcome to the Moxa NPort 5400 Series of advanced serial device servers, which make it easy to enable network operation of your serial devices. All device servers in the series come with four serial ports. On the NPort 5410, the serial ports are RS-232 ports; on the NPort 5430/5430I, the serial ports are RS-422/485 ports; on the NPort 5450/5450I, the serial ports are RS-232/422/485 ports.

The following topics are covered in this chapter:

- Overview**
- Package Checklist**
- Product Features**
- Product Specifications**

Overview

The NPort 5400 Series device servers are designed to make your industrial serial devices Internet ready instantly. The compact size of the NPort 5400 device servers makes them the ideal choice for connecting RS-232/422/485 serial devices—such as PLCs, meters, and sensors—to an IP-based Ethernet LAN, making it possible for your software to access serial devices anywhere over a local LAN or the Internet.

The NPort 5400 serial device servers ensure the compatibility of network software that uses a standard network API (Winsock or BSD Sockets) by providing TCP Server Mode, TCP Client Mode, and UDP Mode. And thanks to the NPort's Real COM/TTY drivers, software that works with COM/TTY ports can be set up to work over a TCP/IP network in no time. This excellent feature preserves your software investment and lets you enjoy the benefits of networking your serial devices instantly.

The NPort 5400 serial device servers support automatic IP configuration protocols (DHCP, BOOTP) and manual configuration via the NPort's handy web browser console. Both methods ensure quick and effective installation. And with the NPort 5400's Windows Utility, installation is very straightforward, since all system parameters can be stored and then copied to other device servers simultaneously.

Package Checklist

The Moxa NPort 5400 Series products are shipped with the following items:

Standard Accessories

- 1 NPort 5400 4-port serial device server
- NPort Document & Software CD
- NPort 5400 Series Quick Installation Guide
- Product Warranty Statement

Optional Accessories

- DK-35A DIN-Rail Mounting Kit (35 mm)

NOTE: *Notify your sales representative if any of the above items is missing or damaged.*

Product Features

The NPort 5400 Series products enjoy the following features:

- Make your serial devices Internet ready
- Easy-to-use LCM (Liquid Crystal Module) interface for setting up the IP address (no support in -T models)
- Versatile socket operation modes, including TCP Server, TCP Client, and UDP
- Easy-to-use Windows Utility for mass installation
- Supports 10/100 Mbps Ethernet—auto detectable
- 2- or 4-wire RS-485 with patented ADDC™ (Automatic Data Direction Control) for NPort 5430, 5430I, 5450, and 5450I
- Built-in 15 KV ESD protection for all serial signals
- Supports SNMP MIB-II for network management
- NPort 5430I/5450I has 2 KV isolation protection
- Adjustable RS-485 termination resistor

Product Specifications

LAN

| | |
|------------|------------------------------------|
| Ethernet | 10/100 Mbps, RJ45 |
| Protection | Built-in 1.5 KV magnetic isolation |

NPort 5410 Serial Interface

| | |
|------------------------|--|
| Interface | RS-232 |
| No. of Ports | 4 |
| Port Type | DB9 Male |
| Signals | TxD, RxD, RTS, CTS, DTR, DSR, DCD, GND |
| Serial Line Protection | 15 KV ESD for all signals |

NPort 5430/5430I Serial Interface

| | |
|------------------------|---|
| Interface | RS-422/485 |
| No. of Ports | 4 |
| Port Type | Terminal Block |
| Signals | RS-422: Tx+, Tx-, Rx+, Rx-, GND RS-485 (2-wire): Data+, Data-, GND RS-485 (4-wire): Tx+, Tx-, Rx+, Rx-, GND |
| Serial Line Protection | 15 KV ESD for all signals |
| RS-485 Data Direction | ADDCTM (Automatic Data Direction Control) |

NPort 5450/5450I Serial Interface

| | |
|--------------|--|
| Interface | RS-232/422/485 |
| No. of Ports | 4 |
| Port Type | DB9 Male |
| Signals | RS-232: TxD, RxD, RTS, CTS, DTR, DSR, DCD, |

| | |
|------------------------|--|
| | GND |
| RS-422: | Tx+, Tx-, Rx+, Rx-, GND |
| RS-485 (2-wire): | Data+, Data-, GND |
| RS-485 (4-wire): | Tx+, Tx-, Rx+, Rx-, GND |
| Serial Line Protection | 15 KV ESD for all signals |
| RS-485 Data Direction | ADDC™ (Automatic Data Direction Control) |

Power Line Protection

Level 2 Burst (EFT), EN61000-4-4

Level 2 Surge, EN61000-4-5

Advanced Built-in Features

HMI LCM display with four push buttons (no support in wide temp. model)

Buzzer

Real-Time Clock

Watch Dog Timer

Serial Communication Parameters

| | |
|--------------------|---|
| Parity | None, Even, Odd, Space, Mark |
| Data Bits | 5, 6, 7, 8 |
| Stop Bit | 1, 1.5, 2 |
| Flow Control | RTS/CTS, XON/XOFF, DSR/DTR (NPort 5410, 5450, and 5450I only) |
| Transmission Speed | 50 bps to 921.6 Kbps |

Software Features

| | |
|-------------------|---|
| Protocols | ICMP, IP, TCP, UDP, DHCP, BOOTP, Telnet, DNS, SNMP, HTTP, SMTP, SNTP, Rtelnet, ARP |
| Utilities | NPort Administrator for Windows (98, ME, NT, 2000, XP x86/x64, 2003 x86/x64, Vista x86/x64, 2008 x86/x64, XP embedded) NPort CE Driver Manager for Windows CE 5.0/6.0 |
| OS Driver Support | Windows Real COM drivers for: Windows (98, ME, NT, 2000, XP x86/x64, Vista x86/x64, 2008 x86/x64, CE 5.0/6.0, XP embedded) Linux Real TTY driver for: Linux 2.4 x86/x64, 2.6 x86/x64 kernel UNIX Fixed TTY drivers for: SCO Unix/OpenServer 5/OpenServer 6/UnixWare 7, UnixWare 2.1, SVR4.2, QNX 4.25, QNX 6, Solaris 10 (x86/SPARC), FreeBSD 5.x/6.x |
| Configuration | Web Browser, Telnet Console, or Windows Utility |

Power Requirements

| | |
|-------------------|---|
| Power Input | 12 to 48 VDC |
| Power Consumption | NPort 5410: 350 mA (at 12V max.) NPort 5430: 320 mA (at 12V max.) NPort 5430I: 530 mA (at 12V max.) |

NPort 5450: 350 mA (at 12V max.)

NPort 5450I: 554 mA (at 12V max.)

Mechanical

Material

SECC sheet metal (0.8 mm)

Dimensions (W × H × D)

With mounting kit: 176 × 35.5 × 103 mm
(6.93 × 1.4 × 4.06 inch)

Without mounting kit: 158 × 33 × 103 mm
(6.22 × 1.3 × 4.06 inch)

Gross Weight

740g

Installation

DIN-Rail, Wall Mounting

Environment

Operating Temperature

Standard Models: 0 to 55°C (32 to 131°F)

Wide Temp. Models: -40 to 75°C (-40 to 167°F)

Storage Temperature

-40 to 75°C (-40 to 167°F)

Humidity

5 to 95% RH

Regulatory Approvals

EMC

FCC Class A, CE Class A

Safety

UL60950-1, EN60950-1

Marine

DNV

Medical

EN60601-1-2 Class B, EN55011

Warranty

5 years

2

Getting Started

This chapter includes information about installing NPort 5400 Series device servers. The following topics are covered:

- ❑ **Panel Layout**
- ❑ **Connecting the Hardware**
 - Wiring Requirements
 - Connecting the Power
 - Grounding the NPort 5400
 - Connecting to the Network
 - Connecting to a Serial Device
 - LED Indicators
 - Adjustable Pull High/low Resistors for the RS-485 Port

Panel Layout

NPort 5410/5450/5450I

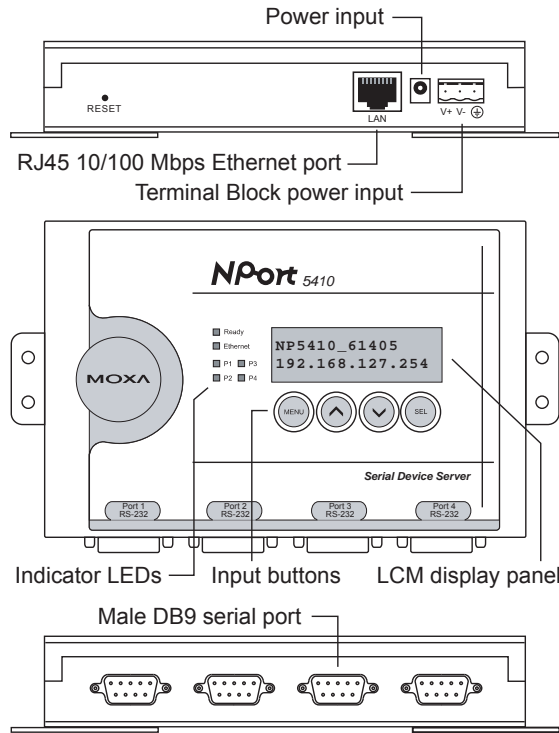

NPort 5430/5430I

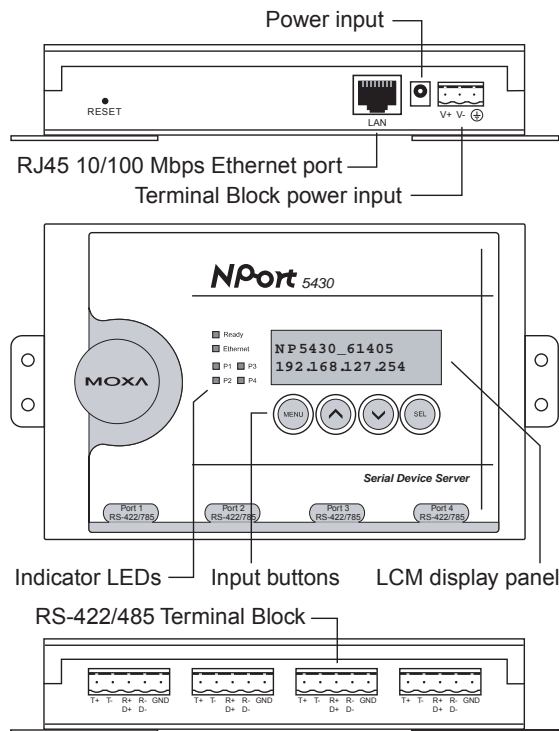

NPort 5450-T / 5450I-T

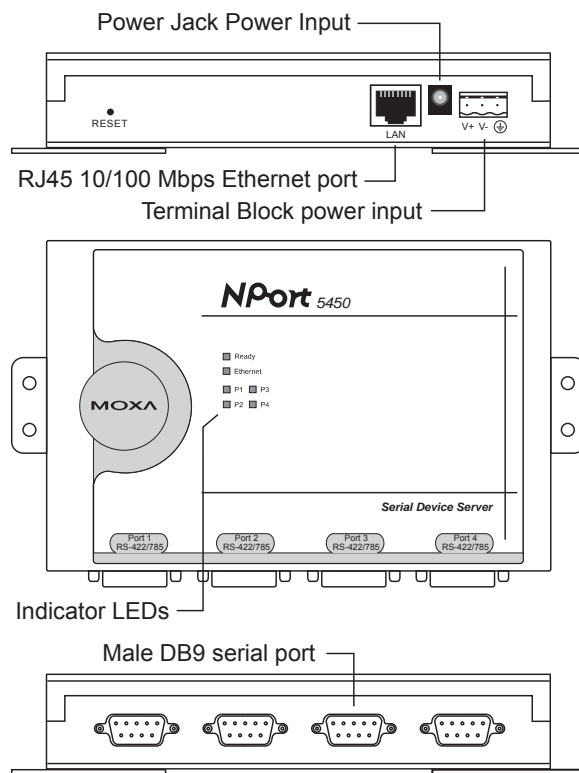

Connecting the Hardware

This section describes how to connect the NPort 5400 to serial devices for first time testing purposes. We cover **Wiring Requirements**, **Connecting the Power**, **Grounding the NPort 5400**, **Connecting to the Network**, **Connecting to a Serial Device**, and **LED Indicators**.

Wiring Requirements



ATTENTION

Safety First!

Be sure to disconnect the power cord before installing and/or wiring your NPort 5400.

Wiring Caution!

Calculate the maximum possible current in each power wire and common wire. Observe all electrical codes dictating the maximum current allowable for each wire size.

If the current goes above the maximum ratings, the wiring could overheat, causing serious damage to your equipment.

Temperature Caution!

Please take care when handling the NPort 5400. When plugged in, the NPort 5400's internal components generate heat, and consequently the casing may feel hot to the touch.

You should heed the following:

- Use separate paths to route wiring for power and devices. If power wiring and device wiring paths must cross, make sure the wires are perpendicular at the intersection point.

NOTE: Do not run signal or communication wiring and power wiring in the same wire conduit. To avoid interference, wires with different signal characteristics should be routed separately.

- You can use the type of signal transmitted through a wire to determine which wires should be kept separate. The rule of thumb is that wiring that shares similar electrical characteristics can be bundled together.
- Keep input wiring and output wiring separate.
- Where necessary, it is strongly advised that you label wiring to all devices in the system.

Connecting the Power

Connect the 12-48 VDC power line with the NPort 5400's terminal block. If the power is properly supplied, the "Ready" LED will show a solid red color until the system is ready, at which time the "Ready" LED will change to a green color.

Grounding the NPort 5400

Grounding and wire routing helps limit the effects of noise caused by electromagnetic interference (EMI). Run the ground connection from the ground screw to the grounding surface prior to connecting devices.



ATTENTION

This product is intended to be mounted to a well-grounded mounting surface such as a metal panel.

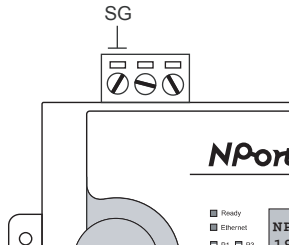

SG: The *Shielded Ground* (sometimes called *Protected Ground*) contact is the left most contact of the 3-pin power terminal block connector when viewed from the angle shown here. Connect the SG wire to an appropriate grounded metal surface.

Connecting to the Network

Connect one end of the Ethernet cable to the NPort 5400's 10/100M Ethernet port and the other end of the cable to the Ethernet network. If the cable is properly connected, the NPort 5400 will indicate a valid connection to the Ethernet in the following ways:

- The Ethernet LED maintains a solid green color when connected to a 100 Mbps Ethernet network.
- The Ethernet LED maintains a solid yellow color when connected to a 10 Mbps Ethernet network.
- The Ethernet LED will flash when Ethernet packets are being transmitted or received.

Connecting to a Serial Device

Connect the serial data cable between the NPort 5400 and the serial device.

LED Indicators

The top panels of the NPort 5400 have four LED indicators, as described in the following table.

| LED Name | LED Color | LED Function |
|--|-----------|---|
| Ready | red | Steady on: Power is on and NPort is booting up. |
| | | Blinking: Indicates an IP conflict, or DHCP or BOOTP server did not respond properly. |
| | green | Steady on: Power is on and NPort is functioning normally. |
| Blinking: The NPort has been located by NPort Administrator's Location function. | | |
| Ethernet | off | Power is off, or power error condition exists. |
| | orange | 10 Mbps Ethernet connection. |
| | green | 100 Mbps Ethernet connection. |
| P1, P2, P3, P4 | off | Ethernet cable is disconnected, or has a short. |
| | orange | Serial port is receiving data. |
| | green | Serial port is transmitting data. |
| | off | No data is being transmitted or received through the serial port. |

Adjustable Pull High/low Resistors for the RS-485 Port

In some critical environments, you may need to add termination resistors to prevent the reflection of serial signals. When using termination resistors, it is important to set the pull high/low resistors correctly so that the electrical signal is not corrupted. Since there is no resistor value that works for every environment, DIP switches are used to set the pull high/low resistor values for each RS-485 port.

To set the pull high/low resistors to 150 K Ω , make sure both of the assigned DIP switches are in the OFF position. This is the default setting.

To set the pull high/low resistors to 1 K Ω , make sure both of the assigned DIP switches are in the ON position.

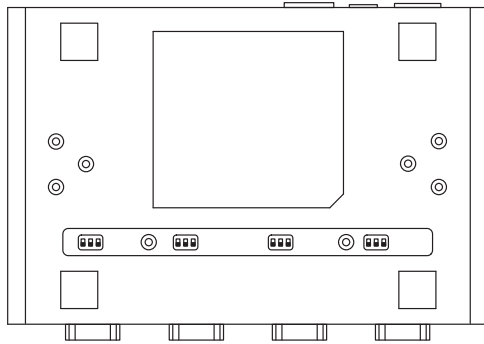

Pull high/low resistors for the RS-485 Port

| SW | 1 | 2 | 3 |
|----------------|----------------|----------------|--------------|
| | Pull High | Pull Low | Terminator |
| ON | 1 K Ω | 1 K Ω | 120 Ω |
| Default OFF | 150 K Ω | 150 K Ω | --- |



ATTENTION

Do not set the resistors to 1 K Ω . when using RS-232. Doing so will degrade the RS-232 signals and reduce the effective communication distance.

Initial IP Address Configuration

When setting up your NPort 5400 series products for the first time, the first thing you should do is configuring the IP address. This chapter introduces the method to configure the NPort's IP address. **Select one of the initial IP Address configuration methods to configure the NPort's IP Address.** For more details about network settings, see the Network Settings section from Chapter 5, **Web Console Configuration**.

This chapter includes the following sections:

- Initializing the NPort's IP Address**
- Factory Default IP Address**
- LCM Display (No support in NPort 5450-T/5450I-T)**
- NPort Administration Suite** ← *recommended configuration method*
- ARP**
- Telnet Console**

Initializing the NPort's IP Address

1. Determine whether your NPort needs to use a Static IP or Dynamic IP (either DHCP or BOOTP application).
2. *If the NPort is used in a Static IP environment*, you can use LCM Display, NPort Administration Suite, ARP, Web Console, or Telnet Console to configure the new IP address.
3. *If the NPort is used in a Dynamic IP environment*, you can use LCM Display, NPort Administration suite, Web Console, or Telnet Console to configure the NPort to get an IP address dynamically with DHCP, DHCP/BOOTP, or BOOTP.



ATTENTION

Consult your network administrator on how to reserve a fixed IP address for your NPort 5400 in the MAC-IP mapping table when using a DHCP Server or BOOTP Server. In most applications, you should assign a fixed IP address to your NPort.

Factory Default IP Address

NPort products are configured with the following default private IP address:

Default IP address: 192.168.127.254

(IP addresses of the form 192.168.xxx.xxx are referred to as private IP addresses, since it is not possible to directly access a device configured with a private IP address from a public network. For example, you would not be able to ping such a device from an outside Internet connection. NPort applications that require sending data over a public network, such as the Internet, require setting up the server with a valid public IP address, which can be leased from a local ISP.)

LCM Display (No support in NPort 5450-T/5450I-T)

We recommend using the LCM display and four push buttons to configure the IP address at the first installation.

Basic Operation

If the NPort is working properly, the LCM panel will display a green color. The red Ready LED will also light up, indicating that the NPort is receiving power. After the red Ready LED turns to green, you will see a display similar to:

| | | | | | | | | | | | | | | |
|---|---|---|---|---|---|---|---|---|---|---|---|---|---|---|
| N | P | 5 | 4 | 1 | 0 | _ | 6 | 1 | 4 | 0 | 5 | | | |
| 1 | 9 | 2 | . | 1 | 6 | 8 | . | 1 | 2 | 7 | . | 2 | 5 | 4 |

This is where

- NP5410 is the NPort's name
- 61405 is the NPort's serial number
- 192.168.127.254 is the NPort's IP address

There are four push buttons on the NPort's nameplate. Going from left to right, the buttons are:

| Button | Name | Action |
|--------|-------------|---|
| MENU | menu | activates the main menu, or returns to a lower level |
| △ | up cursor | scrolls up through a list of items shown on the LCM panel's second line |
| ▽ | down cursor | scrolls down through a list of items shown on the LCM panel's second line |
| SEL | select | selects the option listed on the LCM panel's second line |

The buttons are manipulated in a manner similar to the way a modern cellular phone operates. As you move through the various functions and setting options, note that the top line shows the current menu or submenu name, and the bottom line shows the submenu name or menu item which is activated by pressing the SEL button.

Detailed Menu Options

The best way to explain all of the NPort's LCM functions is to refer to the tree graph shown in the next page. There are three main levels—1, 2, and 3—with each level represented by a separate column.

The first thing to remember is that the menu button is used to move back and forth between the LCM panel's default screen, and main menu screen:

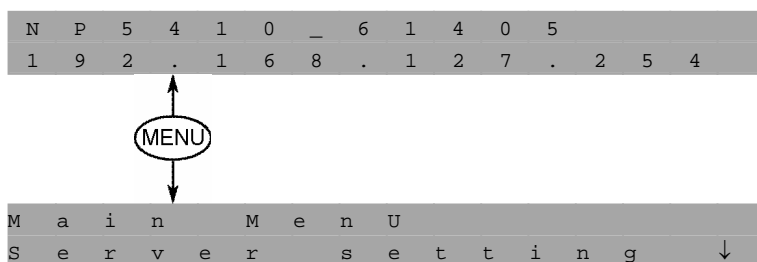

In addition, you only need to remember to:

- Use the SEL button to move up one level (i.e., left to right on the tree graph)
- Use the MENU button to move down one level (i.e., right to left on the tree graph)
- Use the cursor keys, △ and ▽, to scroll between the various options within a level (i.e., up and down on the tree graph).

As you use the buttons to operate the LCM display, you will notice that with very few exceptions, moving up one level causes the bottom line of the display to move to the top line of the display. You will also notice that the bottom three options in level 2, and all of the options in level 3 have either a C or D attached. The meaning is as follows:

- C = configurable
I.e., you are allowed to change the setting of this option
- D = display only
I.e., the setting for this option is displayed, but it cannot be changed (This does NOT necessarily mean that the number does not change; only that you cannot change it)

| | | | | | | |
|-----------|-----------------|--|----------------|---------------|-----------------|--|
| Main Menu | | | | | | |
| | Server setting | Serial number Server name Firmware ver Model name | | | | D C D D |
| | Network setting | Ethernet status MAC address IP config IP address Netmask Gateway DNS server 1 DNS server 2 | | | | D D C C C C C C |
| | Serial set | Select port Baudrate Data bit Stop bit Parity Flow control Tx/Rx fifo Interface Tx/Rx bytes Line status | | | | C C C C C C C C D D |
| | Op Mode set | Select port Select mode [mode] | | | | C C |
| | | Real COM | TCP server | TCP client | UDP svr/cli | |
| | | Alive timeout | Alive timeout | Alive timeout | Delimiter 1 | C |
| | | Max connection | Inact. time | Inact. time | Delimiter 2 | C |
| | | Delimiter 1 | Max connection | Delimiter 1 | Force Tx | C |
| | | Delimiter 2 | Delimiter 1 | Delimiter 2 | Dest IP start-1 | C |
| | | Force Tx | Delimiter 2 | Force Tx | Dest IP end-1 | C |
| | | | Force Tx | Dest IP-1 | Dest port-1 | C |
| | | | Local TCP port | TCP port-1 | Dest IP start-2 | C |
| | | | Command port | Dest IP-2 | Dest IP end-2 | C |
| | | | | TCP port-2 | Dest port-2 | C |
| | | | | Dest IP-3 | Dest IP start-3 | C |
| | | | | TCP port-3 | Dest IP end-3 | C |
| | | | | Dest IP-4 | Dest port-3 | C |
| | | | | TCP port-4 | Dest IP start-4 | C |
| | | | | TCP connect | Dest IP end-4 | C |
| | | | | | Dest port-4 | C |
| | | | | | Local port | C |
| | Console | Web console Telnet console | | | | C C |
| | Ping | | | | | C |
| | Save/Restart | | | | | C |

The part of the LCM operation that still requires some explanation is how to edit the configurable options. In fact, you will only encounter two types of configurable options.

The first type involves entering numbers, such as IP addresses, Netmasks, etc. In this case, you change the number one digit at a time. The up cursor (Δ) is used to decrease the highlighted digit, the down cursor (∇) is used to increase the highlighted digit, and the SEL button is used to move to the next digit. When the last digit has been changed, pressing SEL simply enters the number into the NPort 5400 Series' memory.

The second type of configurable option is when there are only a small number of options from which to choose (although only one option will be visible at a time). Consider the PARITY attribute under PORT SETTING as an example. Follow the tree graph to arrive at the following PARITY screen. The first option, NONE, is displayed, with a down arrow all the way to the right. This is an indication that there are other options from which to choose.

```
P a r i t y
N o n e ↓
```

Press the down cursor button once to see Odd as the second option.

```
P a r i t y ↑
O d d ↓
```

Press the down cursor button again to see Even as the third option.

```
P a r i t y ↑
E v e n ↓
```

Press the down cursor button again to see Space as the fourth option.

```
P a r i t y ↑
M a r k ↓
```

Press the down cursor button yet again to see the last option, Space.

```
P a r i t y ↑
S p a c e
```

To choose the desired option, press the SEL button when the option is showing on the screen.

NPort Administration Suite

NPort Administration Suite consists of some useful utility programs that are used to configure and manage your NPort device server.

See Chapter 5 for details on how to install NPort Administration Suite, and how to use this suite of useful utilities to set up IP addresses and configure your NPort.

ARP

You can make use of the ARP (Address Resolution Protocol) command to set up an IP address for your NPort. The ARP command tells your computer to associate the NPort's MAC address with the intended IP address. You must then use Telnet to access the NPort, at which point the device server's IP address will be reconfigured.



ATTENTION

In order to use this setup method, both your computer and the NPort must be connected to the same LAN.

Or, you may use a cross-over Ethernet cable to connect the NPort directly to your computer's Ethernet card.

Your NPort must be configured with the factory default IP address—192.168.127.254—before executing the ARP command, as described below.

Take the following steps to use ARP to configure the IP address:

1. Obtain a valid IP address for your NPort from your network administrator.
2. Obtain the NPort's MAC address from the label on its bottom panel.
3. Execute the 'arp -s' command from your computer's MS-DOS prompt by typing:

```
arp -s 192.168.200.100 00-90-E8-xx-xx-xx
```

This is where 192.168.200.100 is the new IP address and 00-90-E8-xx-xx-xx is the MAC address for your NPort. You will need to change both numbers, as described above in points 1 and 2.

4. Next, execute a special Telnet command by typing:

```
telnet 192.168.200.100 6000
```

After issuing this command, a **Connect failed** message will appear, as shown here. After the NPort reboots, its IP address should be updated to the new address, and you can reconnect using either Telnet, Web, or Administrator to check that the update was successful.



Telnet Console

Depending on how your computer and network are configured, you may find it convenient to use network access to set up your NPort's IP address. This can be done using the Telnet program.

1. From the Windows desktop, click on **Start** and then select **Run**.
2. Type `telnet 192.168.127.254` (use the correct IP address if different from the default) in the **Open** text input box, and then click **OK**.

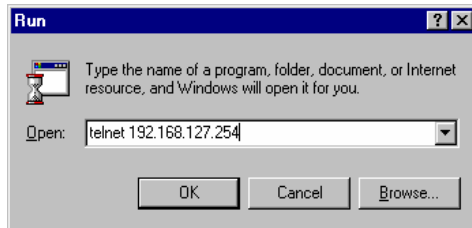

3. When the Telnet window opens, if you are prompted to input the **Console password**, input the password and then press **Enter**.

Note that this page will only appear if the NPort is password protected.

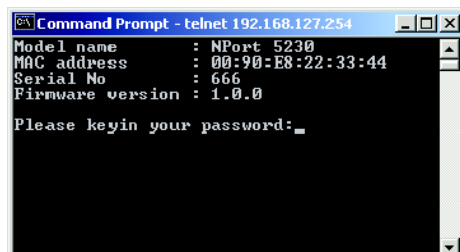

4. Type **2** to select **Network settings**, and then press **Enter**.

```
<< Main Menu >>
(1) Basic settings
(2) Network settings
(3) Serial settings
(4) Operating settings
(5) Accessible IP settings
(6) Auto warning settings
(7) Monitor
(8) Ping
(9) Change password
(a) Load factory default
(v) View settings
(s) Save/Restart
(q) Quit

Key in your selection: 2
```

5. Type **1** to select **IP address** and then press **Enter**.

```
<< Main Menu->Network settings >>
(1) IP address
(2) Netmask
(3) Gateway
(4) IP configuration
(5) DNS server 1
(6) DNS server 2
(7) SNMP
(8) SNMP community name
(9) SNMP contact
(a) SNMP location
(b) Auto IP report to IP
(c) Auto IP report to TCP port
(d) Auto IP report period
(v) View settings
(m) Back to main menu
(q) Quit

Key in your selection: 1_
```

6. Use the Backspace key to erase the current IP address, type in the new IP address, and then press **Enter**.

```
<< Main Menu->Network settings >>
(1) IP address
(2) Netmask
(3) Gateway
(4) IP configuration
(5) DNS server 1
(6) DNS server 2
(7) SNMP
(8) SNMP community name
(9) SNMP contact
(a) SNMP location
(b) Auto IP report to IP
(c) Auto IP report to TCP port
(d) Auto IP report period
(v) View settings
(m) Back to main menu
(q) Quit

Key in your selection: 1
IP address: 192.168.127.253_
```

7. Press any key to continue...

```
<< Main Menu->Network settings >>
(1) IP address
(2) Netmask
(3) Gateway
(4) IP configuration
(5) DNS server 1
(6) DNS server 2
(7) SNMP
(8) SNMP community name
(9) SNMP contact
(a) SNMP location
(b) Auto IP report to IP
(c) Auto IP report to TCP port
(d) Auto IP report period
(u) View settings
(m) Back to main menu
(q) Quit

Key in your selection: 1
IP address: 192.168.127.253
Set IP address success

Press any key to continue...
```

8. Type **m** and then press **Enter** to return to the main menu.

```
<< Main Menu->Network settings >>
(1) IP address
(2) Netmask
(3) Gateway
(4) IP configuration
(5) DNS server 1
(6) DNS server 2
(7) SNMP
(8) SNMP community name
(9) SNMP contact
(a) SNMP location
(b) Auto IP report to IP
(c) Auto IP report to TCP port
(d) Auto IP report period
(u) View settings
(m) Back to main menu
(q) Quit

Key in your selection: m
```

9. Type **s** and then press **Enter** to **Save/Restart** the system.

```
<< Main Menu >>
(1) Basic settings
(2) Network settings
(3) Serial settings
(4) Operating settings
(5) Accessible IP settings
(6) Auto warning settings
(7) Monitor
(8) Ping
(9) Change password
(a) Load factory default
(u) View settings
(s) Save/Restart
(q) Quit

Key in your selection: s
```

10. Type **y** and then press **Enter** to save the new IP address and restart the NPort.

```
Ready to restart
(y) Yes
(n) No

Key in your selection: y
```

Choosing the Proper Operation Mode

In this chapter, we describe the various NPort 5400 operation modes. The options include an operation mode that uses a driver installed on the host computer, and operation modes that rely on TCP/IP socket programming concepts. After choosing the proper operation mode in this chapter, refer to Chapter 5 for detailed configuration parameter definitions.

The following topics are covered in this chapter:

- Overview**
- Real COM Mode**
- TCP Server Mode**
- TCP Client Mode**
- UDP Mode**
- Pair Connection Mode**
- Reverse Telnet Mode**
- Disabled Mode**

Overview

NPort device servers enable network operation of traditional RS-232/422/485 devices, in which a device server is a tiny computer equipped with a CPU, real-time OS, and TCP/IP protocols that can bi-directionally translate data between the serial and Ethernet formats. Your computer can access, manage, and configure remote facilities and equipment over the Internet from anywhere in the world.

Traditional SCADA and data collection systems rely on serial ports (RS-232/422/485) to collect data from various kinds of instruments. Since NPort serial device servers enable network operation of instruments equipped with an RS-232/422/485 communication port, your SCADA and data collection system will be able to access all instruments connected to a standard TCP/IP network, regardless of whether the devices are used locally or at a remote site.

The NPort is an external IP-based network device that allows you to expand the number of serial ports for a host computer on demand. As long as your host computer supports the TCP/IP protocol, you won't be limited by the host computer's bus limitation (such as ISA or PCI), or lack of drivers for various operating systems.

In addition to providing socket access, the NPort also comes with a Real COM/TTY driver that transmits all serial signals intact. This means that your existing COM/TTY-based software can be preserved, without needing to invest in additional software.

Three different Socket Modes are available: TCP Server, TCP Client, and UDP Server/Client. The main difference between the TCP and UDP protocols is that TCP guarantees delivery of data by requiring the recipient to send an acknowledgement to the sender. UDP does not require this type of verification, making it possible to offer speedier delivery. UDP also allows multicasting of data to groups of IP addresses.

Real COM Mode

The NPort comes equipped with COM drivers that work with Windows systems, and also TTY drivers for Linux systems. The driver establishes a transparent connection between host and serial device by mapping the IP:Port of the NPort's serial port to a local COM/TTY port on the host computer. This operation mode also supports up to 4 simultaneous connections, so that multiple hosts can collect data from the same serial device at the same time.

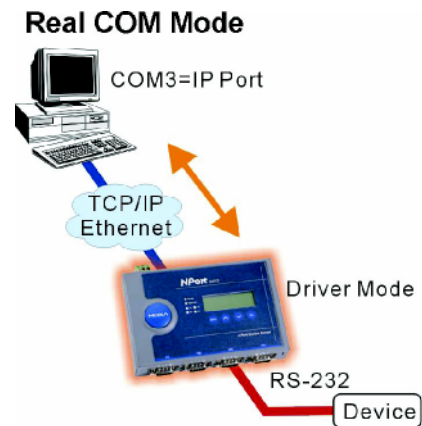

ATTENTION

The driver used for Real COM Mode comes with the NPort Windows Administrator. The driver is installed automatically on your computer when you install NPort Administration Suite.

The important point is that Real COM Mode allows users to continue using RS-232/422/485 serial communications software that was written for pure serial communications applications. The driver intercepts data sent to the host's COM port, packs it into a TCP/IP packet, and then redirects it through the host's Ethernet card. At the other end of the connection, the NPort accepts the Ethernet frame, unpacks the TCP/IP packet, and then transparently sends it to the appropriate serial device attached to one of the NPort's serial ports.



ATTENTION

Real COM Mode allows several hosts to have access control over the same NPort. The driver that comes with your NPort controls host access to attached serial devices by checking the host's IP address. Modify the Accessible IP Setting table when the legal IP address should be required in your application

TCP Server Mode

In TCP Server mode, the NPort provides a unique IP:Port address on a TCP/IP network. The NPort waits passively to be contacted by the host computer, allowing the host computer to establish a connection with and get data from the serial device. This operation mode also supports up to 4 simultaneous connections, so that multiple hosts can collect data from the same serial device—at the same time.

As illustrated in the figure, data transmission proceeds as follows:

1. The host requests a connection from the NPort configured for TCP Server Mode.
2. Once the connection is established, data can be transmitted in both directions—from the host to the NPort, and from the NPort to the host.

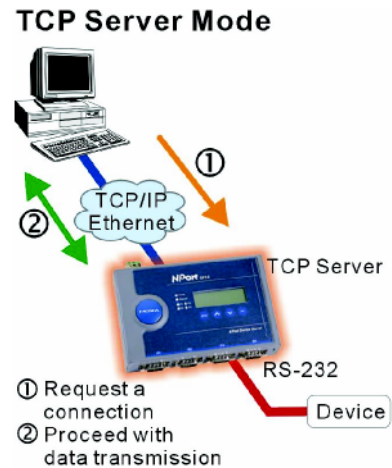

TCP Client Mode

In **TCP Client mode**, the NPort can actively establish a TCP connection to a pre-defined host computer when serial data arrives.

After the data has been transferred, the NPort can automatically disconnect from the host computer by using the **TCP alive check time** or **Inactivity time** settings. Refer to chapter 5 for more details.

As illustrated in the figure, data transmission proceeds as follows:

1. The NPort configured for TCP Client Mode requests a connection from the host.
2. Once the connection is established, data can be transmitted in both directions—from the host to the NPort, and from the NPort to the host.

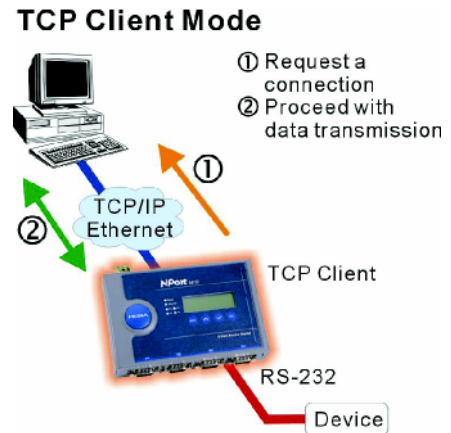

UDP Mode

Compared to TCP communication, UDP is faster and more efficient. In UDP mode, you can multicast data from the serial device to multiple host computers, and the serial device can also receive data from multiple host computers, making this mode ideal for message display applications.

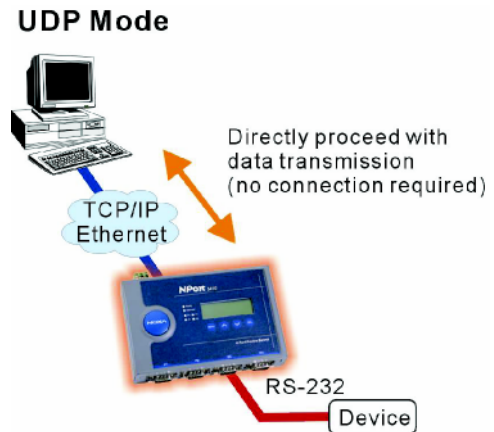

Pair Connection Mode

Pair Connection Mode employs two NPort 5400 units in tandem, and can be used to remove the 15-meter distance limitation imposed by the RS-232 interface. One NPort 5400 is connected from its RS-232 port to the COM port of a PC or other type of computer, such as a hand-held PDA, and the serial device is connected to the RS-232 port of the other NPort 5400. The two NPort 5400 units are then connected to each other with a cross-over Ethernet cable, both are connected to the same LAN, or in a more advanced setup, they communicate with each other over a WAN (i.e., through one or more routers). Pair Connection Mode transparently transfers both data and modem control signals (although it cannot transmit the DCD signal) between the two NPort device servers.

Reverse Telnet Mode

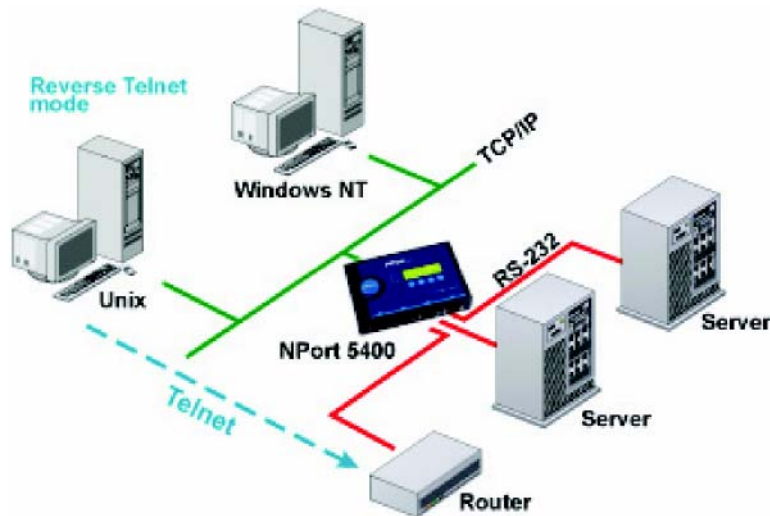

Console management is commonly used by connecting to Console/AUX or COM ports of routers, switches, and UPS units. Rtelnet works the same as RAW mode in that only one TCP port is listened to after booting up. The system then waits for a host on the network to initiate a connection. The difference is that the RAW mode does not provide the conversion function provided by Telnet. If the connected devices need to use the CR/LF conversion function when controlling, then users must choose Rtelnet mode.

Disabled Mode

When the Operation Mode for a particular port is set to **Disabled**, that port will be disabled.

Web Console Configuration

The Web Console is the most user-friendly way to configure the NPort 5400 series products. This chapter will introduce the Web Console function groups and function definitions. This chapter uses the NPort 5410 as an example. The function and definition is totally the same with NPort 5400 series devices servers.

- Opening Your Browser**
- Basic Settings**
- Network Settings**
- SNMP Settings**
 - IP Address Report
- Serial Settings**
 - Serial Parameters
- Operating Settings**
 - Real COM Mode
 - TCP Server Mode
 - TCP Client Mode
 - UDP Mode
 - Pair Connection Mode
 - Reverse Telnet Mode
 - Disabled Mode
- Accessible IP Settings**
- Auto Warning Settings**
 - Auto warning: E-mail and SNMP trap
 - Event Type
- Monitor**
 - Monitor Line
 - Monitor Async
 - Monitor Async-Settings
- Change Password**
- Load Factory Default**

Opening Your Browser

1. Open your browser with the cookie function enabled. (To enable your browser for cookies, right click on your desktop Internet Explorer icon, select Properties, click on the Security tab, and then select the three Enable options as shown in the figure below.)

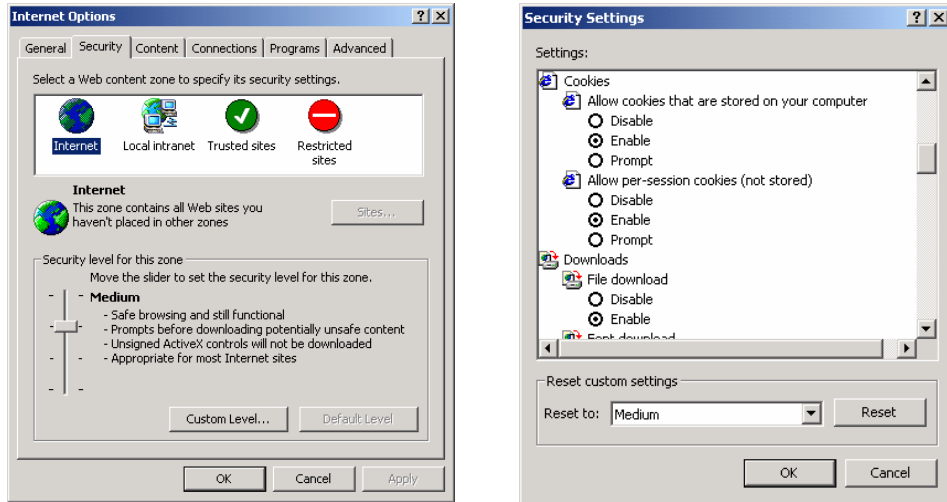

2. Type **192.168.127.254** in the **Address** input box (use the correct IP address if different from the default), and then press **Enter**.
3. Input the password if prompted. The password will be transmitted with MD5 encryption over the Ethernet.
Note that you will not be prompted to enter the password if the NPort is not currently password protected.

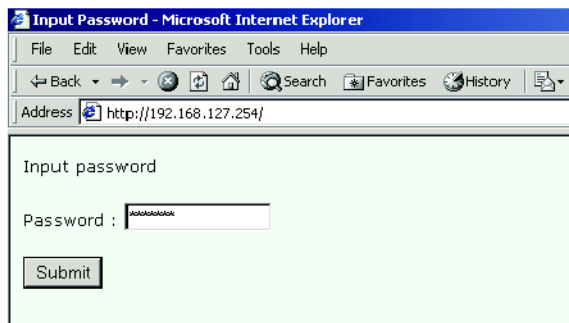

ATTENTION

If you use other web browsers, remember to Enable the functions to “allow cookies that are stored on your computer” or “allow per-session cookies.”

NPort 5400 device servers use cookies only for “password” transmission.



ATTENTION

Refer to Chapter 3, “Initial IP Address Configuration,” to see how to configure the IP address. Examples shown in this chapter use the Factory Default IP address (192.168.127.254).

The NPort 5410 homepage will open. On this page, you can see a brief description of the Web Console's nine function groups.



ATTENTION

If you can't remember the password, the **ONLY** way to start configuring the NPort is to load factory defaults by using the Reset button located near the NPort's RJ45 Ethernet port. Remember to use NPort Administrator to export the configuration file when you have finished the configuration. After using the Reset button to load factory defaults, your configuration can be easily reloaded into the NPort by using the NPort Administrator Import function. Refer to Chapter 6 for more details about using the Export and Import functions.



ATTENTION

If your NPort application requires using password protection, you must enable the cookie function in your browser. If the cookie function is disabled, you will not be allowed to enter the Web Console Screen.

Basic Settings

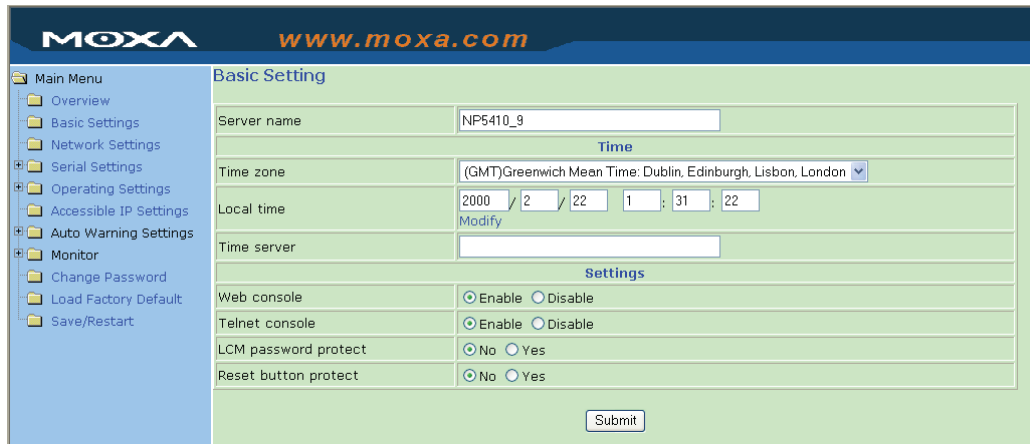

Server name

| Setting | Factory Default | Necessity |
|--------------------|-----------------------------|-----------|
| 1 to 39 characters | NP[model name]_[Serial No.] | Optional |

This option is useful for specifying the location or application of different NPort device servers.

Time

The NPort 5410 has a built-in Real-Time Clock for time calibration functions. Functions such as Auto warning “Email” or “SNMP Trap” can add real-time information to the message.

Before making any adjustments to the time, first select the correct time zone and submit the change. The console will display the real time according to the time zone. To modify the real time clock, click on **Modify** next to the **Local time** field. Once you submit the new time, the NPort 5400’s firmware will modify the GMT time according to your time zone and local time settings.



ATTENTION

There is a risk of explosion if the real-time clock battery is replaced with the wrong type!

The NPort 5400’s real time clock is powered by a lithium battery. We strongly recommend that you do not attempt replacement of the lithium battery without help from a qualified Moxa support engineer. If you need to change the battery, please contact the Moxa RMA service team.

Time zone

| Setting | Factory Default | Necessity |
|---------------------------|---------------------------|-----------|
| User selectable time zone | GMT (Greenwich Mean Time) | Required |

Local time

| Setting | Factory Default | Necessity |
|--|---------------------------|-----------|
| User adjustable time (1900/1/1-2037/12/31) | GMT (Greenwich Mean Time) | Required |

Click on the **Modify** button to open the **Modify time settings** window to input the correct local time.



Time server

| Setting | Factory Default | Necessity |
|--|-----------------|-----------|
| IP or Domain address (E.g., 192.168.1.1 or time.stdtime.gov.tw or time.nist.gov) | None | Optional |

The NPort 5410 uses SNTP (RFC-1769) for auto time calibration.

Input the correct “Time Server” IP address or domain address. Once the NPort is configured with the correct Time Server address, the NPort will request time information from the “Time Server” every 10 minutes.

Web/Telnet Console

The “Disable” option for “Web Console” and “Telnet Console” is included for security reasons. In some cases, you may want to disable one or both of these console utilities as an extra precaution to prevent unauthorized users from accessing your NPort 5400. The factory default for both Web console and Telnet console is **Enable**.

Web console

| Setting | Factory Default | Necessity |
|-------------------|-----------------|-----------|
| Enable or Disable | Enable | Required |

Telnet console

| Setting | Factory Default | Necessity |
|-------------------|-----------------|-----------|
| Enable or Disable | Enable | Required |



ATTENTION

If you disable both the “Web console” and “Telnet console,” you can still use NPort Administrator to configure NPort 5400 device servers either locally or remotely over the network. Refer to Chapter 6 for more details.

LCM password protect (NPort 5450-T/5450I-T not support)

| Setting | Factory Default | Necessity |
|-----------|-----------------|-----------|
| No or Yes | No | Required |

Select **Yes** to use the web console password to enter the LCM utility. If the console password is blank, the LCM password will also be blank. To enter the password using the LCM buttons, use the scroll buttons to locate a particular character, press **SEL**, enter the next character in the password, press **SEL**, etc. Once the password has been entered, press **SEL** until the LCM screen is activated.

Reset button protect

| Setting | Factory Default | Necessity |
|-----------|-----------------|-----------|
| No or Yes | No | Required |

Options are **No** and **Yes**, with default = **No**.

NOTE: Select the **Yes** option to allow limited use of the Reset Button. In this case, the Reset Button can be used for only 60 seconds. I.e., 60 sec. after booting up, the Reset Button will be disabled automatically.

Network Settings



You must assign a valid IP address to the NPort 5410 before it will work in your network environment. Your network system administrator should provide you with an IP address and related settings for your network. The IP address must be unique within the network (otherwise, the NPort 5410 will not have a valid connection to the network). First time users can refer to Chapter 3, *Initial IP Address Configuration*, for more information.

You can choose from four possible IP Configuration modes—**Static**, **DHCP**, **DHCP/BOOTP**, and **BOOTP**—located under the web console screen's IP configuration drop-down box.

| Method | Function Definition |
|------------|--|
| Static | User defined IP address, Netmask, Gateway. |
| DHCP | DHCP Server assigned IP address, Netmask, Gateway, DNS, and Time Server |
| DHCP/BOOTP | DHCP Server assigned IP address, Netmask, Gateway, DNS, and Time Server, or BOOTP Server assigned IP address |
| BOOTP | BOOTP Server assigned IP address |

IP Address

| Setting | Factory Default | Necessity |
|---|-----------------|-----------|
| E.g., 192.168.1.1 (IP addresses of the form <i>x.x.x.0</i> and <i>x.x.x.255</i> are invalid.) | 192.168.127.254 | Required |

An IP address is a number assigned to a network device (such as a computer) as a permanent address on the network. Computers use the IP address to identify and talk to each other over the network. Choose a proper IP address which is unique and valid in your network environment.

Netmask

| Setting | Factory Default | Necessity |
|---------------------|-----------------|-----------|
| E.g., 255.255.255.0 | 255.255.255.0 | Required |

A subnet mask represents all the network hosts at one geographic location, in one building, or on the same local area network. When a packet is sent out over the network, the NPort will use the subnet mask to check whether the desired TCP/IP host specified in the packet is on the local network segment. If the address is on the same network segment as the NPort, a connection established directly from the NPort. Otherwise, the connection is established through the given default gateway.

Gateway

| Setting | Factory Default | Necessity |
|-------------------|-----------------|-----------|
| E.g., 192.168.1.1 | None | Optional |

A gateway is a network gateway that acts as an entrance to another network. Usually, the computers that control traffic within the network or at the local Internet service provider are gateway nodes. The NPort needs to know the IP address of the default gateway computer in order to communicate with the hosts outside the local network environment. For correct gateway IP address information, consult the network administrator.

IP Configuration

| Setting | Factory Default | Necessity |
|---------------------------------------|-----------------|-----------|
| Static DHCP DHCP/BOOTP BOOTP | Static | Required |

**ATTENTION**

In Dynamic IP environments, the firmware will retry 3 times every 30 seconds until network settings are assigned by the DHCP or BOOTP server. The Timeout for each try increases from 1 second, to 3 seconds, to 5 seconds.

If the DHCP/BOOTP Server is unavailable, the firmware will use the default IP address (192.168.127.254), Netmask, and Gateway for IP settings.

DNS server 1 / DNS server 2

| Setting | Factory Default | Necessity |
|--|-----------------|-----------|
| E.g., 192.168.1.1 (IP addresses of the form <i>x.x.x.0</i> and <i>x.x.x.255</i> are invalid.) | None | Optional |

When the user wants to visit a particular website, the computer asks a Domain Name System (DNS) server for the website's correct IP address, and the computer uses the response to connect to the web server. DNS is the way that Internet domain names are identified and translated into IP addresses. A domain name is an alphanumeric name, such as *moxa.com*, that it is usually easier to remember. A DNS server is a host that translates this kind of text-based domain name into the numeric IP address used to establish a TCP/IP connection.

In order to use the NPort's DNS feature, you need to set the IP address of the DNS server to be able to access the host with the domain name. The NPort provides **DNS server 1** and **DNS server 2** configuration items to configure the IP address of the DNS server. DNS Server 2 is included for use when DNS sever 1 is unavailable.

The NPort plays the role of DNS client. Functions that support domain name in the NPort are **Time Sever IP Address**, **TCP Client-Destination IP Address**, **Mail Server**, **SNMP Trap IP Address**, and **IP Location Server**.

SNMP Settings

Community Name

| Setting | Factory Default | Necessity |
|--|-----------------|-----------|
| 1 to 39 characters (E.g., Support, 886-89191230 #300) | public | Optional |

A community name is a plain-text password mechanism that is used to weakly authenticate queries to agents of managed network devices.

Contact

| Setting | Factory Default | Necessity |
|--|-----------------|-----------|
| 1 to 39 characters (E.g., Support, 886-89191230 #300) | None | Optional |

The SNMP contact information usually includes an emergency contact name and telephone or pager number.

Location

| Setting | Factory Default | Necessity |
|---|-----------------|-----------|
| 1 to 39 characters (E.g., Floor 1, office 2) | None | Optional |

Specify the location string for SNMP agents such as NPort. This string is usually set to the street address where the NPort is physically located.

IP Address Report

When device servers in the NPort 5000 line are used in a dynamic IP environment, users must spend more time with IP management tasks. For example, the NPort works as a server (TCP or UDP), and the host, which acts as a client, must know the IP address of the server. If the DHCP server assigns a new IP address to the server, the host must take care of what happens when the IP changes.

Device servers in the NPort 5000 line help out by periodically reporting their IP address to the IP location server, in case the dynamic IP has changed. The parameters shown below are used to configure the Auto IP report function. There are two ways to develop an "Auto IP report Server" to receive the NPort's Auto IP report.

1. Use NPort Administrator's IP Address Report function.
2. Refer the Appendix E for the "Auto IP report protocol" to develop your own software.

Auto report to IP

| Setting | Factory Default | Necessity |
|---|-----------------|-----------|
| E.g., 192.168.1.1 or URL (IP addresses of the form <i>x.x.x.0</i> and <i>x.x.x.255</i> are invalid.) | None | Optional |

Reports generated by the Auto report function will be automatically sent to this IP address.

Auto report to UDP port

| Setting | Factory Default | Necessity |
|------------|-----------------|-----------|
| E.g., 4001 | 4002 | Optional |

Auto report period

| Setting | Factory Default | Necessity |
|----------------------------|-----------------|-----------|
| Time interval (in seconds) | 10 | Optional |

Serial Settings

Click on **Serial Settings**, located under **Main Menu**, to display serial port settings for ports 1 and 2.

The screenshot shows the Moxa web console interface. On the left is a navigation menu with 'Serial Settings' expanded to show 'Port 1', 'Port 2', 'Port 3', and 'Port 4'. The main content area displays a table titled 'Serial Settings' with the following data:

| | Alias | Baud rate | Data bits | Stop bits | Parity | FIFO | Flow ctrl | Interface |
|--------|-------|-----------|-----------|-----------|--------|--------|-----------|-----------|
| Port 1 | | 115200 | 8 | 1 | None | Enable | RTS/CTS | RS-232 |
| Port 2 | | 115200 | 8 | 1 | None | Enable | RTS/CTS | RS-232 |
| Port 3 | | 115200 | 8 | 1 | None | Enable | RTS/CTS | RS-232 |
| Port 4 | | 115200 | 8 | 1 | None | Enable | RTS/CTS | RS-232 |

To modify serial settings for a particular port, click on either **Port 1** or **Port 2** under **Serial Settings**.

The screenshot shows the detailed configuration page for 'Port = 01'. The 'Port alias' field contains 'PLC-1'. Under 'Serial Parameters', the following settings are shown:

- Baud rate: 115200
- Data bits: 8
- Stop bits: 1
- Parity: None
- Flow control: RTS/CTS
- FIFO: Enable Disable
- Interface: RS-232 Only

There is a checkbox for 'Apply the above settings to all serial ports' and a 'Submit' button at the bottom.

Port alias

| Setting | Factory Default | Necessity |
|--|-----------------|-----------|
| 1 to 15 characters (E.g., PLC-No.1) | None | Optional |

Port Alias is specially designed to allow easy identification of the serial devices which are connected to the NPort's serial port.

Serial Parameters



ATTENTION

Check the serial communication parameters in your Serial Device's user's manual. You should set up the NPort's serial parameters with the same communication parameters used by your serial devices.

Baud rate

| Setting | Factory Default | Necessity |
|----------------------|-----------------|-----------|
| 50 bps to 921600 bps | 115200 bps | Required |

The NPort supports baud rate setting from 50 bps to 921.6 Kbps.

Data bits

| Setting | Factory Default | Necessity |
|------------|-----------------|-----------|
| 5, 6, 7, 8 | 8 | Required |

When the user sets Data bits to 5 bits, the stop bits setting will automatically change to 1.5 bits.

Stop bits

| Setting | Factory Default | Necessity |
|---------|-----------------|-----------|
| 1, 2 | 1 | Required |

Stop bits will be set to 1.5 when Data bits is set to 5 bits.

Parity

| Setting | Factory Default | Necessity |
|------------------------------|-----------------|-----------|
| None, Even, Odd, Space, Mark | None | Required |

Flow control

| Setting | Factory Default | Necessity |
|----------------------------------|-----------------|-----------|
| None, RTS/CTS, DTR/DSR, Xon/Xoff | RTS/CTS | Required |

FIFO

| Setting | Factory Default | Necessity |
|-----------------|-----------------|-----------|
| Enable, Disable | Enable | Required |

The NPort's serial ports provide a 16-byte FIFO both in the Tx and Rx directions. Disable the FIFO setting when your serial device does not have a FIFO to prevent data loss during communication.

Interface

| Setting | Factory Default | Necessity |
|--|---------------------------|-----------|
| NPort 5410: RS-232 only | NPort 5410: RS-232 | Required |
| NPort 5430: RS-422, 2-wire RS-485, 4-wire RS-485 | NPort 5430: 2-wire RS-485 | Required |
| NPort 5450: RS-232, RS-422, 2-wire RS-485, 4-wire RS-485 | NPort 5450: RS-232 | Required |

Operating Settings

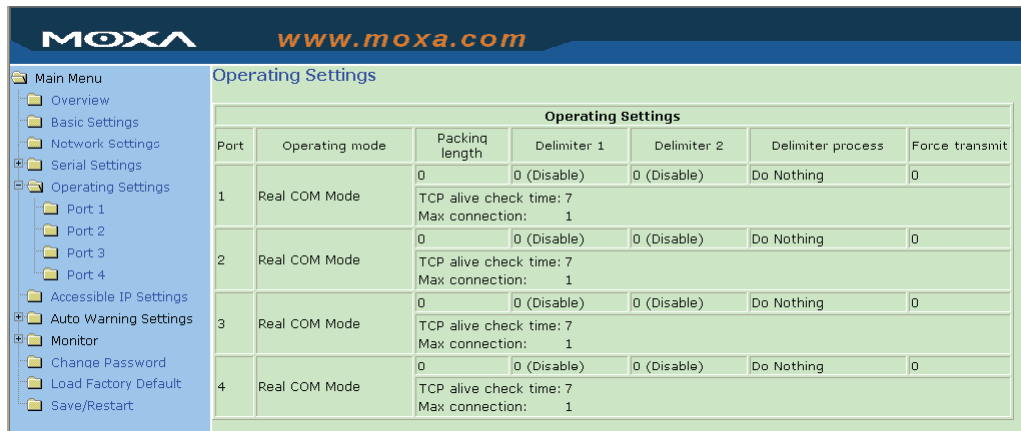

Press **Operating Settings** to display the operating settings for each of the NPort's serial ports.

Real COM Mode

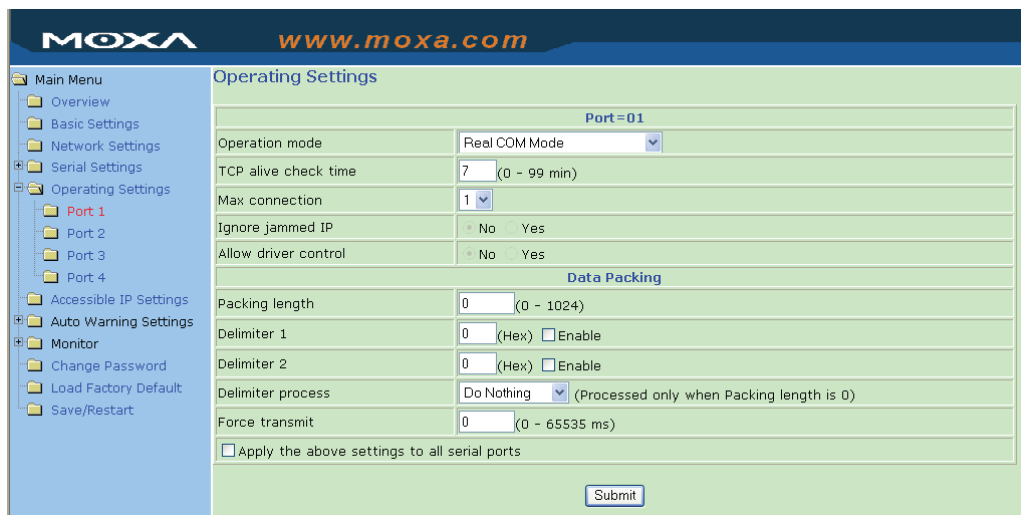

TCP alive check time

| Setting | Factory Default | Necessity |
|-------------|-----------------|-----------|
| 0 to 99 min | 7 min | Optional |

0 min: TCP connection is not closed due to an idle TCP connection.

1 to 99 min: The NPort automatically closes TCP connection if there is no TCP activity for the given time. After the connection is closed, the NPort starts listening for another Real COM driver's connection from another host.

Max connection

| Setting | Factory Default | Necessity |
|------------|-----------------|-----------|
| 1, 2, 3, 4 | 1 | Required |

Max connection is usually used when the user needs to receive data from different hosts simultaneously. The factory default only allows 1 connection at a same. When Max Connection is set to 1, the Real COM driver on the specific host has the full control.

Max. Connection 1:

Allows only 1 host's Real COM driver to open the specific NPort serial port.

Max Connection 2 to 4:

Allows 2 to 4 host's Real COM drivers to open the specific NPort serial port, at the same time. When multiple hosts' Real COM drivers open the serial port at the same time, the COM driver only provides a pure data tunnel without control ability. That is, this serial port parameter will use firmware's settings, not depend on your application program (AP).

Application software that is based on the COM driver will receive a driver response of "success" when the software uses any of the Win32 API functions. The firmware will only send the data back to the driver on the host.

Data will be sent first-in-first-out when data comes into the NPort from the Ethernet interface.

**ATTENTION**

When Max connection is set to 2, 3, or 4, this means that the NPort will be using a "multi connection application" (i.e., 2, 3, or 4 hosts are allowed access to the port at the same time). When using a multi connection application, the NPort will use the serial communication parameters set in the console. All of the hosts connected to that port must use the same serial settings. If one of the hosts opens the COM port with parameters that are different from the NPort's console setting, data communication may not work properly.

Ignore jammed IP

| Setting | Factory Default | Necessity |
|-----------|-----------------|-----------|
| No or Yes | No | Optional |

Previously, when Max connections > 1, and the serial device is transmitting data, if any one of the connected hosts is not responding, it will wait until the data has been transmitted successfully before transmitting the second group of data to all hosts. Currently, if you select Yes for "Ignore jammed IP," the host that is not responding will be ignored, but the data will still be transmitted to the other hosts.

Packing length

| Setting | Factory Default | Necessity |
|-----------|-----------------|-----------|
| 0 to 1024 | 0 | Optional |

Default = 0, The Delimiter Process will be followed, regardless of the length of the data packet. If the data length (in bytes) matches the configured value, the data will be forced out. The data length can be configured for 0 to 1024 bytes. Set to 0 if you do not need to limit the length.

Delimiter 1

| Setting | Factory Default | Necessity |
|----------|-----------------|-----------|
| 00 to FF | None | Optional |

Delimiter 2

| Setting | Factory Default | Necessity |
|----------|-----------------|-----------|
| 00 to FF | None | Optional |

Once the NPort receives both delimiters through its serial port, it immediately packs all data currently in its buffer and sends it to the NPort's Ethernet port.

**ATTENTION**

Delimiter 2 is optional. If left blank, then Delimiter 1 alone trips clearing of the buffer. If the size of the serial data received is greater than 1 KB, the NPort will automatically pack the data and send it to the Ethernet. However, to use the delimiter function, you must at least enable Delimiter 1. If Delimiter 1 is left blank and Delimiter 2 is enabled, the delimiter function will not work properly.

Delimiter process

| Setting | Factory Default | Necessity |
|---|-----------------|-----------|
| Do nothing Delimiter + 1 Delimiter + 2 Strip Delimiter | Do Nothing | Optional |

[Delimiter + 1] or [Delimiter + 2]: The data will be transmitted when an additional byte (for Delimiter +1), or an additional 2 bytes (for Delimiter +2) of data is received after receiving the Delimiter.

[Strip Delimiter]: When the Delimiter is received, the Delimiter is deleted (i.e., stripped), and the remaining data is transmitted.

[Do nothing]: The data will be transmitted when the Delimiter is received.

Force transmit

| Setting | Factory Default | Necessity |
|---------------|-----------------|-----------|
| 0 to 65535 ms | 0 ms | Optional |

0: Disable the force transmit timeout.

1 to 65535: Forces the NPort's TCP/IP protocol software to try to pack serial data received during the specified time into the same data frame.

This parameter defines the time interval during which the NPort fetches the serial data from its internal buffer. If data is incoming through the serial port, the NPort stores the data in the internal buffer. The NPort transmits data stored in the buffer via TCP/IP, but only if the internal buffer is full or if the force transmit time interval reaches the time specified under Force Transmit timeout.

Optimal force transmit timeout differs according to your application, but it must be at least larger than one character interval within the specified baudrate. For example, assume that the serial port is set to 1200 bps, 8 data bits, 1 stop bit, and no parity. In this case, the total number of bits needed to send a character is 10 bits, and the time required to transfer one character is

$10 \text{ (bits)} / 1200 \text{ (bits/s)} * 1000 \text{ (ms/s)} = 8.3 \text{ ms}$.

Therefore, you should set Force Transmit timeout to be larger than 8.3 ms. Force Transmit timeout is specified in milliseconds and must be larger than 10 ms.

If the user wants to send the series of characters in a packet, the serial device attached to the NPort should send characters without time delay larger than Force Transmit timeout between characters and the total length of data must be smaller than or equal to the NPort's internal buffer size. The serial communication buffer size of the NPort is 1 Kbytes per port.

TCP Server Mode



TCP alive check time

| Setting | Factory Default | Necessity |
|-------------|-----------------|-----------|
| 0 to 99 min | 7 min | Optional |

0 min: TCP connection is not closed due to an idle TCP connection.

1 to 99 min: The NPort automatically closes the TCP connection if there is no TCP activity for the given time. After the connection is closed, the NPort starts listening for another host's TCP connection.

Inactivity time

| Setting | Factory Default | Necessity |
|---------------|-----------------|-----------|
| 0 to 65535 ms | 0 ms | Optional |

0 ms: TCP connection is not closed due to an idle serial line.

0-65535 ms: The NPort automatically closes the TCP connection if there is no serial data activity for the given time. After the connection is closed, the NPort starts listening for another host's TCP connection.

This parameter defines the maintenances status as Closed or Listen on the TCP connection. The connection is closed if there is no incoming or outgoing data through the serial port during the specific Inactivity time.

If the value of inactivity time is set to 0, the current TCP connection is maintained until there is connection close request. Although inactivity time is disabled, the NPort will check the connection status between the NPort and remote host by sending “keep alive” packets periodically. If the remote host does not respond to the packet, it assumes that the connection was closed down unintentionally. The NPort will then force the existing TCP connection to close.

**ATTENTION**

The Inactivity time should at least be set larger than that of Force transmit timeout. To prevent the unintended loss of data due to the session being disconnected, it is highly recommended that this value is set large enough so that the intended data transfer is completed.

Max Connection

| Setting | Factory Default | Necessity |
|------------|-----------------|-----------|
| 1, 2, 3, 4 | 1 | Required |

Max Connection is usually used when the user needs to receive data from different hosts simultaneously. The factory default only allows 1 connection at a time.

Max. Connection 1:

NPort only allows 1 host to open the TCP connection to the specific serial port.

Max Connection 2 to 4:

Allows 2 to 4 host's TCP connection request to open the specific NPort serial port, at the same time. When multiple hosts establish a TCP connection to the specific serial port at the same time, the NPort will duplicate the serial data and transmit to all of the hosts. Ethernet data is sent on a first-in-first-out basis to the serial port when data comes into the NPort from the Ethernet interface.

Ignore jammed IP

| Setting | Factory Default | Necessity |
|-----------|-----------------|-----------|
| No or Yes | No | Optional |

Previously, when Max connections > 1, and the serial device is transmitting data, if any one of the connected hosts is not responding, it will wait until the data has been transmitted successfully before transmitting the second group of data to all hosts. Currently, if you select Yes for “Ignore jammed IP,” the host that is not responding will be ignored, but the data will still be transmitted to the other hosts.

Allow driver control

| Setting | Factory Default | Necessity |
|-----------|-----------------|-----------|
| No or Yes | No | Optional |

If “max connection” is greater than 1, the NPort will ignore driver control commands from all connected hosts. However, if you set “Allow driver control” to YES, control commands will be accepted. Note that since the NPort 5400 may get configuration changes from multiple hosts, the most recent command received will take precedence.

Packing length

| Setting | Factory Default | Necessity |
|-----------|-----------------|-----------|
| 0 to 1024 | 0 | Optional |

Default = 0, The Delimiter Process will be followed, regardless of the length of the data packet. If the data length (in bytes) matches the configured value, the data will be forced out. The data length can be configured for 0 to 1024 bytes. Set to 0 if you do not need to limit the length.

Delimiter 1

| Setting | Factory Default | Necessity |
|----------|-----------------|-----------|
| 00 to FF | None | Optional |

Delimiter 2

| Setting | Factory Default | Necessity |
|----------|-----------------|-----------|
| 00 to FF | None | Optional |

Once the NPort receives both delimiters through its serial port, it immediately packs all data currently in its buffer and sends it to the NPort's Ethernet port.

**ATTENTION**

Delimiter 2 is optional. If left blank, then Delimiter 1 alone trips clearing of the buffer. If the size of the serial data received is greater than 1 KB, the NPort will automatically pack the data and send it to the Ethernet. However, to use the delimiter function, you must at least enable Delimiter 1. If Delimiter 1 is left blank and Delimiter 2 is enabled, the delimiter function will not work properly.

Delimiter process

| Setting | Factory Default | Necessity |
|---|-----------------|-----------|
| Do nothing Delimiter + 1 Delimiter + 2 Strip Delimiter | Do Nothing | Optional |

[Delimiter + 1] or [Delimiter + 2]: The data will be transmitted when an additional byte (for Delimiter +1), or an additional 2 bytes (for Delimiter +2) of data is received after receiving the Delimiter.

[Strip Delimiter]: When the Delimiter is received, the Delimiter is deleted (i.e., stripped), and the remaining data is transmitted.

[Do nothing]: The data will be transmitted when the Delimiter is received.

Force transmit

| Setting | Factory Default | Necessity |
|---------------|-----------------|-----------|
| 0 to 65535 ms | 0 ms | Optional |

0: Disable the force transmit timeout.

1 to 65535: Forces the NPort's TCP/IP protocol software to try to pack serial data received during the specified time into the same data frame.

This parameter defines the time interval during which the NPort fetches the serial data from its internal buffer. If there is incoming data through the serial port, the NPort stores data in the internal buffer. The NPort transmits data stored in the buffer via TCP/IP, but only if the internal buffer is full or if the force transmit time interval reaches the time specified as Force Transmit timeout.

Optimal force transmit timeout differs according to your application, but it must be at least as large as one character interval within the specified baud rate. For example, assume that the serial port is set to 1200 bps, 8 data bits, 1 stop bit, and no parity. In this case, the total number of bits required to send a character is 10 bits and the time required to transfer one character is

$$10 \text{ (bits)} / 1200 \text{ (bits/s)} * 1000 \text{ (ms/s)} = 8.3 \text{ ms.}$$

Therefore, you should set Force Transmit timeout to be larger than 8.3 ms. Force Transmit timeout is specified in milliseconds and must be larger than 10 ms.

If the user wants to send a series of character in a packet, the serial device attached to the NPort should send characters without time delay larger than Force Transmit timeout between characters and the total length of data must be smaller than or equal to the NPort's internal buffer size. The NPort's serial communication buffer size is 1K bytes per port.

Local TCP port

| Setting | Factory Default | Necessity |
|------------|-----------------|-----------|
| 1 to 65535 | 4001 | Required |

The TCP port that the NPort uses to listen to connections, and that other devices must use to contact NPort. To avoid conflicts with well known TCP ports, the default is set to 4001.

Command port

| Setting | Factory Default | Necessity |
|------------|-----------------|-----------|
| 1 to 65535 | 966 | Optional |

The command port is a listen TCP port for IP-Serial Lib commands from the host. In order to prevent a TCP port conflict with other applications, the user can adjust the command port to another port if needed. And IP-Serial Lib will automatically check out the Command Port on the NPort so that the user does not need to configure the program.

TCP Client Mode

The screenshot shows the 'Operating Settings' page for Port 01 in TCP Client Mode. The settings are as follows:

- Operation mode:** TCP Client Mode
- TCP alive check time:** 7 (0 - 99 min)
- Inactivity time:** 0 (0 - 65535 ms)
- Ignore jammed IP:** No
- Data Packing:**
 - Packing length:** 0 (0 - 1024)
 - Delimiter 1:** 0 (Hex) [Enable]
 - Delimiter 2:** 0 (Hex) [Enable]
 - Delimiter process:** Do Nothing (Processed only when Packing length is 0)
 - Force transmit:** 0 (0 - 65535 ms)
- TCP Client Mode:**
 - Destination IP Address:** 4001 (for all 4 addresses)
 - Designated Local Port 1:** 5011 (0 - 65535, 0 represents assigned automatically.)
 - Designated Local Port 2:** 5012 (0 - 65535)
 - Designated Local Port 3:** 5013 (0 - 65535)
 - Designated Local Port 4:** 5014 (0 - 65535)
 - Connection control:** Startup/None (Connect on/Disconnect by)

There is a checkbox for 'Apply the above settings to all serial ports' and a 'Submit' button at the bottom.

TCP alive check time

| Setting | Factory Default | Necessity |
|-------------|-----------------|-----------|
| 0 to 99 min | 7 min | Optional |

0 min: TCP connection is not closed due to an idle TCP connection.

1 to 99 min: The NPort automatically closes the TCP connection if there is no TCP activity for the given time.

Inactivity time

| Setting | Factory Default | Necessity |
|---------------|-----------------|-----------|
| 0 to 65535 ms | 0 ms | Optional |

0 ms: TCP connection is not closed due to an idle serial line.

0-65535 ms: The NPort automatically closes TCP connection, if there is no serial data activity for the given time.

This parameter defines the maintenances status as Closed or Listen on the TCP connection. The connection is closed if there is no incoming or outgoing data through the serial port during the specific Inactivity time.

If the value of inactivity time is set to 0, the current TCP connection is maintained until there's connection close request. Although the inactivity time is disabled, the NPort will check the connection status between the NPort and remote host by sending "keep alive" packets periodically. If the remote host does not respond to the packets, it treats the connection as being down

unintentionally. The NPort will then force the existing TCP connection to close.



ATTENTION

The Inactivity time should at least be set larger than that of Force transmit timeout. To prevent the unintended loss of data due to the session being disconnected, it is highly recommended that this value is set large enough so that the intended data transfer is completed.



ATTENTION

Inactivity time is **ONLY** active when “TCP connect on” is set to “Any character.”

Ignore jammed IP

| Setting | Factory Default | Necessity |
|-----------|-----------------|-----------|
| No or Yes | No | Optional |

Previously, when Max connections > 1, and the serial device is transmitting data, if any one of the connected hosts is not responding, it will wait until the data has been transmitted successfully before transmitting the second group of data to all hosts. Currently, if you select Yes for “Ignore jammed IP,” the host that is not responding will be ignored, but the data will still be transmitted to the other hosts.

Packing length

| Setting | Factory Default | Necessity |
|-----------|-----------------|-----------|
| 0 to 1024 | 0 | Optional |

Default = 0, The Delimiter Process will be followed, regardless of the length of the data packet. If the data length (in bytes) matches the configured value, the data will be forced out. The data length can be configured for 0 to 1024 bytes. Set to 0 if you do not need to limit the length.

Delimiter 1

| Setting | Factory Default | Necessity |
|----------|-----------------|-----------|
| 00 to FF | None | Optional |

Delimiter 2

| Setting | Factory Default | Necessity |
|----------|-----------------|-----------|
| 00 to FF | None | Optional |

Once the NPort receives both delimiters through its serial port, it immediately packs all data currently in its buffer and sends it to the NPort’s Ethernet port.



ATTENTION

Delimiter 2 is optional. If left blank, then Delimiter 1 alone trips clearing of the buffer. If the size of the serial data received is greater than 1 KB, the NPort will automatically pack the data and send it to the Ethernet. However, to use the delimiter function, you must at least enable Delimiter 1. If Delimiter 1 is left blank and Delimiter 2 is enabled, the delimiter function will not work properly.

Delimiter process

| Setting | Factory Default | Necessity |
|---|-----------------|-----------|
| Do nothing Delimiter + 1 Delimiter + 2 Strip Delimiter | Do Nothing | Optional |

[Delimiter + 1] or [Delimiter + 2]: The data will be transmitted when an additional byte (for Delimiter +1), or an additional 2 bytes (for Delimiter +2) of data is received after receiving the Delimiter.

[Strip Delimiter]: When the Delimiter is received, the Delimiter is deleted (i.e., stripped), and the remaining data is transmitted.

[Do nothing]: The data will be transmitted when the Delimiter is received.

Force transmit

| Setting | Factory Default | Necessity |
|---------------|-----------------|-----------|
| 0 to 65535 ms | 0 ms | Optional |

0: Disable the force transmit timeout.

1 to 65535: Forces the NPort's TCP/IP protocol software to try to pack serial data received during the specified time into the same data frame.

This parameter defines the interval during which the NPort fetches the serial data from its internal buffer. If there is incoming data through the serial port, the NPort stores data in the internal buffer. The NPort transmits data stored in the buffer via TCP/IP, but only if the internal buffer is full or if the force transmit time interval reaches the time specified as Force Transmit timeout.

Optimal force transmit timeout differs according to your application, but it must be at least as large as one character interval within the specified baud rate. For example, assume that the serial port is set to 1200 bps, 8 data bits, 1 stop bit, and no parity. In this case, the total number of bits required to send a character is 10 bits, and the time required to transfer one character is

$$10 \text{ (bits)} / 1200 \text{ (bits/s)} * 1000 \text{ (ms/s)} = 8.3 \text{ ms.}$$

Therefore, you should set Force Transmit timeout to be larger than 8.3 ms. Force Transmit timeout is specified in milliseconds and must be larger than 10 ms.

If the user wants to send a series of characters in a packet, the serial device attached to the NPort should send characters without time delay larger than Force Transmit timeout between characters and the total length of data must be smaller than or equal to the NPort's internal buffer size. The serial communication buffer size of the NPort is 1 Kbytes per port.

Destination IP address 1

| Setting | Factory Default | Necessity |
|---|-----------------|-----------|
| IP address or Domain Address (E.g., 192.168.1.1) | None | Required |

Allows the NPort to connect actively to the remote host whose address is set by this parameter.

Destination IP address 2/3/4

| Setting | Factory Default | Necessity |
|---|-----------------|-----------|
| IP address or Domain Address (E.g., 192.168.1.1) | None | Required |

Allows the NPort to connect actively to the remote host whose address is set by this parameter.

**ATTENTION**

Up to 4 connections can be established between the NPort and hosts. The connection speed or throughput may be low if one of the four connections is slow, since the slow connection will slow down the other 3 connections.

**ATTENTION**

The “Destination IP address” parameter can use both IP address and Domain Name. For some applications, the user may need to send the data actively to the remote destination domain name.

Designated Local Port 1/2/3/4

| Setting | Factory Default | Necessity |
|--------------|--|-----------|
| TCP Port No. | 5011 (<i>Port 1</i>) 5012 (<i>Port 2</i>) 5013 (<i>Port 3</i>) 5014 (<i>Port 4</i>) | Required |

Connection control

| Setting | Factory Default | Necessity |
|---|-----------------|-----------|
| Startup/None, Any Character/None, Any Character/Inactivity Time, DSR ON/DSR OFF, DSR ON/None, DCD ON/DCD OFF, DCD ON/None | Startup/None | Required |

The meaning of each of the above settings is given in the table below. In general, both the Connect condition and Disconnect condition are given.

| Connect/Disconnect | Description |
|-------------------------------|--|
| Startup/None (default) | A TCP connection will be established on startup, and will remain active indefinitely. |
| Any Character/None | A TCP connection will be established when any character is received from the serial interface, and will remain active indefinitely. |
| Any Character/Inactivity Time | A TCP connection will be established when any character is received from the serial interface, and will be disconnected when the Inactivity time out is reached. |
| DSR On/DSR Off | A TCP connection will be established when a DSR "On" signal is received, and will be disconnected when a DSR "Off" signal is received. |
| DSR On/None | A TCP connection will be established when a DSR "On" signal is received, and will remain active indefinitely. |
| DCD On/DCD Off | A TCP connection will be established when a DCD "On" signal is received, and will be disconnected when a DCD "Off" signal is received. |
| DCD On/None | A TCP connection will be established when a DCD "On" signal is received, and will remain active indefinitely. |

UDP Mode

The screenshot shows the Moxa web console configuration interface. The left sidebar contains a navigation menu with options like Overview, Basic Settings, Network Settings, Serial Settings, Operating Settings (selected), Accessible IP Settings, Auto Warning Settings, Monitor, Change Password, Load Factory Default, and Save/Restart. The main content area is titled 'Operating Settings' and is for 'Port=01'. It includes sections for 'Data Packing' and 'UDP Mode'. The 'Data Packing' section has fields for Packing length (0), Delimiter 1 (0), Delimiter 2 (0), Delimiter process (Do Nothing), and Force transmit (0). The 'UDP Mode' section has a table for Destination IP addresses and a Local Listen port field. A 'Submit' button is located at the bottom of the configuration area.

Packing length

| Setting | Factory Default | Necessity |
|-----------|-----------------|-----------|
| 0 to 1024 | 0 | Optional |

Default = 0, The Delimiter Process will be followed, regardless of the length of the data packet. If the data length (in bytes) matches the configured value, the data will be forced out. The data length can be configured for 0 to 1024 bytes. Set to 0 if you do not need to limit the length.

Delimiter 1

| Setting | Factory Default | Necessity |
|----------|-----------------|-----------|
| 00 to FF | None | Optional |

Delimiter 2

| Setting | Factory Default | Necessity |
|----------|-----------------|-----------|
| 00 to FF | None | Optional |

Once the NPort receives both delimiters through its serial port, it immediately packs all data currently in its buffer and sends it to the NPort's Ethernet port.

Note: Delimiter 2 is optional. If left blank, then Delimiter 1 alone trips clearing of the buffer.

**ATTENTION**

Delimiter 2 is optional. If left blank, then Delimiter 1 alone trips clearing of the buffer. If the size of the serial data received is greater than 1 KB, the NPort will automatically pack the data and send it to the Ethernet. However, to use the delimiter function, you must at least enable Delimiter 1. If Delimiter 1 is left blank and Delimiter 2 is enabled, the delimiter function will not work properly.

Delimiter process

| Setting | Factory Default | Necessity |
|---|-----------------|-----------|
| Do nothing Delimiter + 1 Delimiter + 2 Strip Delimiter | Do Nothing | Optional |

[Delimiter + 1] or [Delimiter + 2]: The data will be transmitted when an additional byte (for Delimiter +1), or an additional 2 bytes (for Delimiter +2) of data is received after receiving the Delimiter.

[Strip Delimiter]: When the Delimiter is received, the Delimiter is deleted (i.e., stripped), and the remaining data is transmitted.

[Do nothing]: The data will be transmitted when the Delimiter is received.

Force transmit

| Setting | Factory Default | Necessity |
|---------------|-----------------|-----------|
| 0 to 65535 ms | 0 ms | Optional |

0: Disable the force transmit timeout.

1 to 65535: Forces the NPort's TCP/IP protocol software to try to pack serial data received during the specified time into the same data frame.

This parameter defines the interval during which the NPort fetches the serial data from its internal buffer. If there is incoming data through the serial port, the NPort stores the data in the internal buffer. The NPort transmits data stored in the buffer via TCP/IP, but only if the internal buffer is full or if the force transmit time interval reaches the time specified as Force Transmit timeout.

Optimal force transmit timeout differs according to your application, but it must be at least as large as one character interval within the specified baud rate. For example, assume that the serial port is set to 1200 bps, 8 data bits, 1 stop bit, and no parity. In this case, the total number of bits required to send a character is 10 bits and the time required to transfer one character is

$$10 \text{ (bits)} / 1200 \text{ (bits/s)} * 1000 \text{ (ms/s)} = 8.3 \text{ ms.}$$

Therefore, you should set the Force Transmit timeout to be larger than 8.3 ms. Force Transmit timeout is specified in milliseconds and must be larger than 10 ms.

If the user wants to send a series of characters in a packet, the serial device attached to the NPort should send characters without time delay larger than Force Transmit timeout between characters and the total length of data must be smaller than or equal to the NPort's internal buffer size. The serial communication buffer size of the NPort is 1 Kbyte per port.

Destination IP address 1

| Setting | Factory Default | Necessity |
|--------------------------|-----------------|-----------|
| IP address range | Begin: Empty | Required |
| E.g., Begin: 192.168.1.1 | End: Empty | |
| End: 192.168.1.10 | Port: 4001 | |

Destination IP address 2/3/4

| Setting | Factory Default | Necessity |
|---------------------------|-----------------|-----------|
| IP address range | Begin: Empty | Optional |
| E.g., Begin: 192.168.1.11 | End: Empty | |
| End: 192.168.1.20 | Port: 4001 | |

Local listen port

| Setting | Factory Default | Necessity |
|------------|-----------------|-----------|
| 1 to 65535 | 4001 | Required |

The UDP port that the NPort listens to, and that other devices must use to contact the NPort. To avoid conflicts with well known UDP ports, the default is set to 4001.

Pair Connection Mode

Pair Connection Mode employs two NPort 5400 device servers in tandem, and can be used to remove the 15-meter distance limitation imposed by the RS-232 interface. One NPort 5400 is connected from its RS-232 port to the COM port of a PC or other type of computer, such as a hand-held PDA, and the serial device is connected to the RS-232 port of the other NPort 5400. The two NPort 5400 device servers are then connected to each other with a cross-over Ethernet cable, both are connected to the same LAN, or in a more advanced setup, they communicate with each other over a WAN (i.e., through one or more routers). Pair Connection Mode transparently transfers both data and modem control signals (although it cannot transmit the DCD signal) between the two NPort device servers.

Pair Connection Master Mode

When using Pair Connection Mode, you must select **Pair Connection Master Mode** for the Operation mode of one of the NPort 5400 device servers. In effect, this NPort 5400 will be acting as a TCP client.

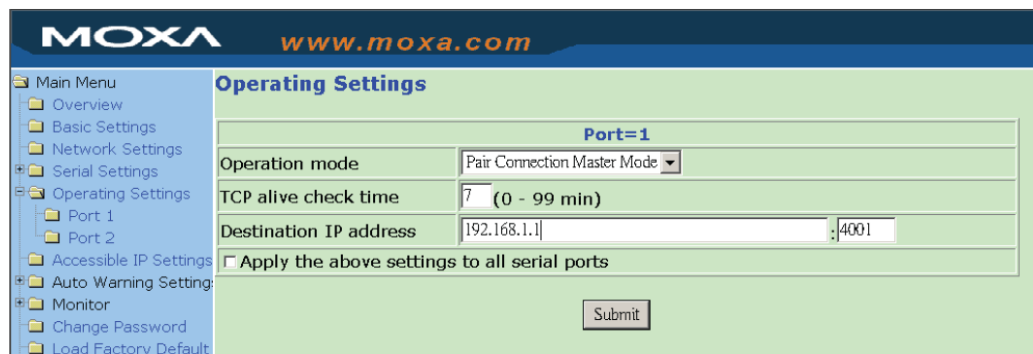

TCP alive check time

| Setting | Factory Default | Necessity |
|-------------|-----------------|-----------|
| 0 to 99 min | 7 min | Required |

0 min: TCP connection is not closed due to an idle TCP connection.

1 to 99 min: The NPort 5400 closes the TCP connection automatically if there is no TCP activity for the given time.

Destination IP address

| Setting | Factory Default | Necessity |
|--|-----------------|-----------|
| IP address or Domain Name (E.g., 192.168.1.1) | blank | Optional |
| TCP port No. | 4001 | Required |

The Pair Connection “Master” will contact the network host that has this IP address. Data will be transmitted through the port No. (4001 by default). Note that you must configure the same TCP port No. for the device server acting as the Pair Connection “Slave.”

Pair Connection Slave Mode

When using Pair Connection Mode, you must select **Pair Connection Slave Mode** for the Operation mode of one of the NPort 5400 device servers. In effect, this NPort 5400 will be acting as a TCP server.

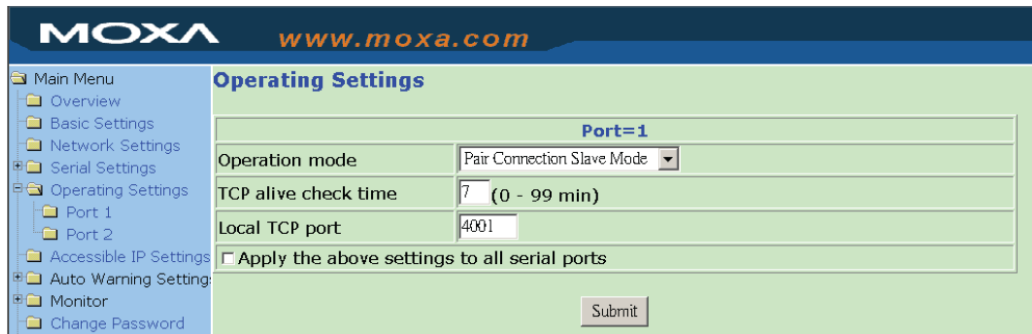

TCP alive check time

| Setting | Factory Default | Necessity |
|-------------|-----------------|-----------|
| 0 to 99 min | 7 min | Required |

0 min: TCP connection is not closed due to an idle TCP connection.

1 to 99 min: The NPort 5400 closes the TCP connection automatically if there is no TCP activity for the given time.

Local TCP port

| Setting | Factory Default | Necessity |
|---------------------------|-----------------|-----------|
| TCP port No. (e.g., 4001) | 4001 | Required |

This Port No. must be the same port No. that you set up for the Pair Connection “Master” device server.

Reverse Telnet Mode

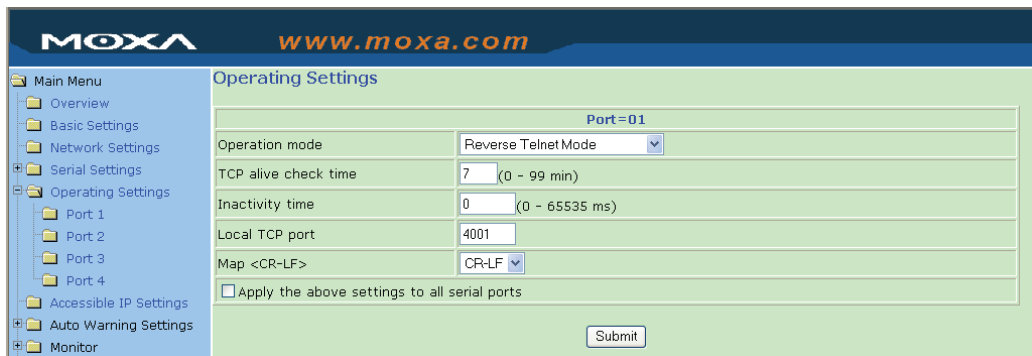

TCP alive check time

| Setting | Factory Default | Necessity |
|-------------|-----------------|-----------|
| 0 to 99 min | 0 | Optional |

Specifies the time slice for checking if the TCP connection is alive. If no response, the NPort 5400 will disconnect the original connection.

Inactivity time

| Setting | Factory Default | Necessity |
|---------------|-----------------|-----------|
| 0 to 65535 ms | 0 | Optional |

Idle time setting for auto-disconnection. 0 min. means it will never disconnect.

Local TCP port

| Setting | Factory Default | Necessity |
|------------|-----------------|-----------|
| 1 to 65535 | 4001 | Optional |

Each of the NPort's serial ports is mapped to a TCP port. To avoid conflicts with TCP ports, set port numbers to 4001 for port1, 4002 for port 2, etc. (like the default values).

Map <CR-LF>

| Setting | Factory Default | Necessity |
|------------------|-----------------|-----------|
| CR, LF, or CR-LF | CR-LF | Optional |

If data received through the NPort 5400's Ethernet port is sent using the "enter" command, the data will be transmitted out the serial port with an added

1. "carriage return + line feed" if you select the <CR-LF> option
(i.e., the cursor will jump to the next line, and return to the first character of the line)
2. "carriage return" if you select the <CR> option
(i.e., the cursor will return to the first character of the line)
3. "line feed" if you select the <LF> option.
(i.e., the cursor will jump to the next line, but not move horizontally)

Disabled Mode

When Operation mode is set to Disabled, that particular port will be disabled. Check the "Apply the above settings to all serial ports" to apply this setting to the other port.

Accessible IP Settings

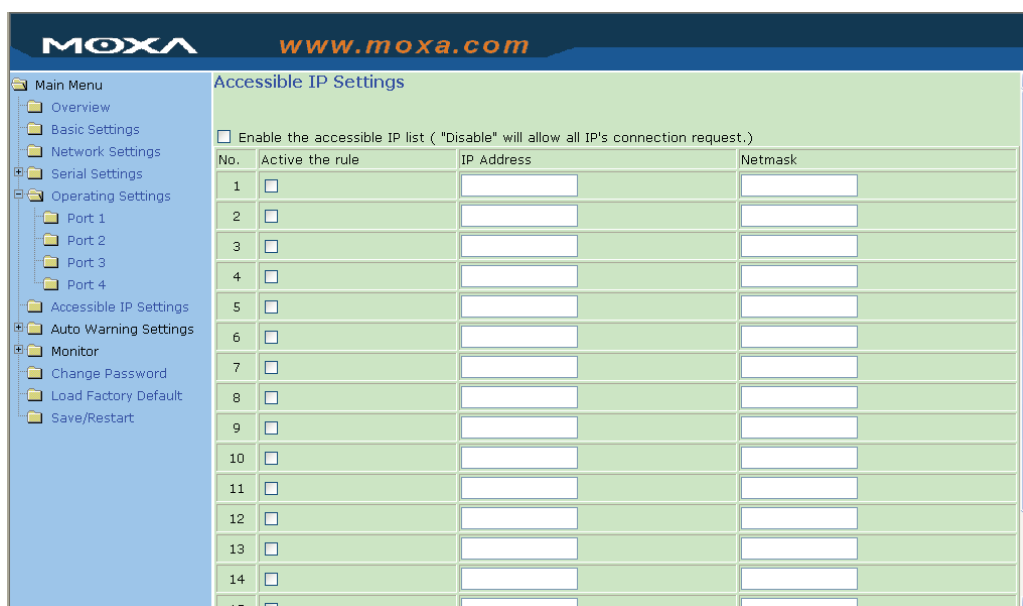

The NPort has an IP address based filtering method to control access to the NPort.

Accessible IP Settings allows you to add or remove “Legal” remote host IP addresses to prevent unauthorized access. Access to the NPort is controlled by IP address. That is, if a host’s IP address is in the accessible IP table, then the host will be allowed access to the NPort. You can allow one of the following cases by setting the parameter.

- Only one host of specific IP address can access the NPort**
 Enter “IP address/255.255.255.255” (e.g., “192.168.1.1/255.255.255.255”).
- Hosts on the specific subnet can access the NPort**
 Enter “IP address/255.255.255.0” (e.g., “192.168.1.0/255.255.255.0”).
- Any host can access the NPort**
 Disable this function. Refer to the following table for more details about the configuration example.

| Allowable Hosts | Input format |
|--------------------------------|---------------------------------|
| Any host | Disable |
| 192.168.1.120 | 192.168.1.120 / 255.255.255.255 |
| 192.168.1.1 to 192.168.1.254 | 192.168.1.0 / 255.255.255.0 |
| 192.168.0.1 to 192.168.255.254 | 192.168.0.0 / 255.255.0.0 |
| 192.168.1.1 to 192.168.1.126 | 192.168.1.0 / 255.255.255.128 |
| 192.168.1.129 to 192.168.1.254 | 192.168.1.128 / 255.255.255.128 |

Auto Warning Settings

Auto warning: E-mail and SNMP trap

The screenshot shows the Moxa web console interface. The title is "Auto warning: Email and SNMP trap". On the left is a navigation menu with categories like Main Menu, Overview, Basic Settings, Network Settings, Serial Settings, Operating Settings (Port 1-4), Accessible IP Settings, Auto Warning Settings (E-mail and SNMP Trap, Event Type), Monitor, Change Password, Load Factory Default, and Save/Restart. The main configuration area has the following fields:

- Mail server:** A text input field.
- My server requires authentication
- User name:** A text input field.
- Password:** A text input field.
- From E-mail address:** A text input field containing "NP5410_9@moxa.com".
- E-mail address 1:** A text input field.
- E-mail address 2:** A text input field.
- E-mail address 3:** A text input field.
- E-mail address 4:** A text input field.
- SNMP trap server:** A section header.
- SNMP trap server IP or domain name:** A text input field.
- Submit:** A button at the bottom right.

Mail Server

Mail server

| Setting | Factory Default | Necessity |
|-------------------|-----------------|-----------|
| IP or Domain Name | None | Optional |

User name

| Setting | Factory Default | Necessity |
|--------------------|-----------------|-----------|
| 1 to 15 characters | None | Optional |

Password

| Setting | Factory Default | Necessity |
|--------------------|-----------------|-----------|
| 1 to 15 characters | None | Optional |

From E-mail address

| Setting | Factory Default | Necessity |
|--------------------|-----------------|-----------|
| 1 to 63 characters | None | Optional |

E-mail address 1/2/3/4

| Setting | Factory Default | Necessity |
|--------------------|-----------------|-----------|
| 1 to 63 characters | None | Optional |



ATTENTION

Consult your Network Administrator or ISP for the proper mail server settings. Auto warning function may not work properly without proper settings. NPort SMTP AUTH supports LOGIN, PLAIN, CRAM-MD5 (RFC 2554).

SNMP Trap Server

SNMP trap server IP or domain name

| Setting | Factory Default | Necessity |
|-------------------|-----------------|-----------|
| IP or Domain Name | None | Optional |

Event Type

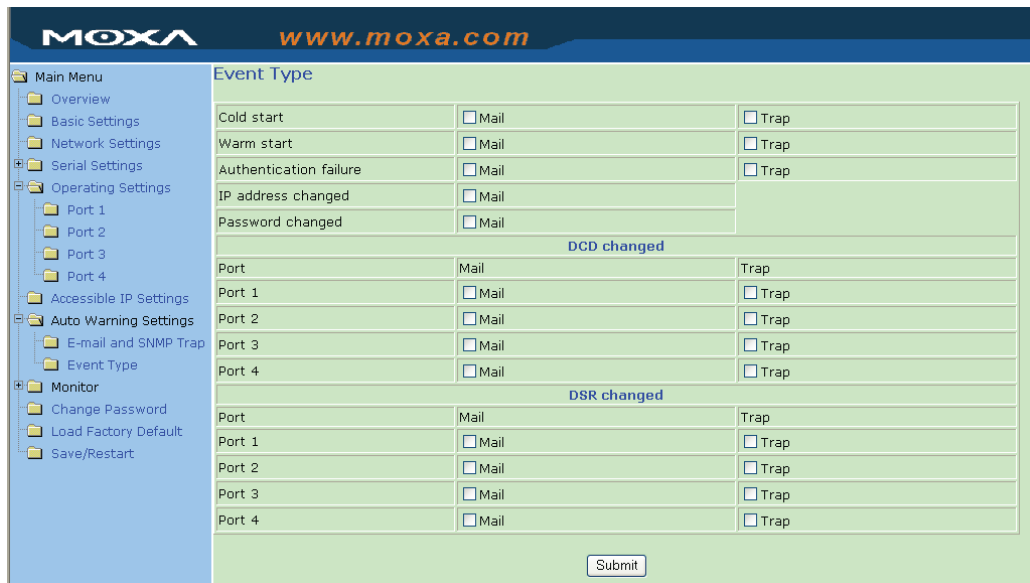

Cold start

This refers to starting the system from power off (contrast this with warm start). When performing a cold start, the NPort will automatically issue an Auto warning message by e-mail, or send an SNMP trap after rebooting.

Warm start

This refers to restarting the computer without turning the power off. It's the opposite of cold start. When performing a warm start, the NPort will automatically send an e-mail, or send an SNMP trap after rebooting.

Authentication failure

The user inputs a wrong password from the Console or Administrator. When authentication failure occurs, the NPort will immediately send an e-mail or send an SNMP trap.

IP address changed

The user has changed the NPort's IP address. When the IP address changes, the NPort will send an e-mail with the new IP address before the NPort reboots. If the NPort fails to send mail to the mail server after 15 seconds, the NPort will be rebooting directly and abort the mail auto warning.

Password changed

The user has changed the NPort's password. When the password changes, the NPort will send an e-mail with the password change notice before the NPort reboots. If the NPort fails to send mail to the mail server after 15 seconds, the NPort will be rebooting directly and abort the mail auto warning.

DCD changed

The DCD (Data Carrier Detect) signal has changed, also indicating that the modem connection status has changed. For example, a DCD change to high also means "Connected" between local modem and remote modem. If the DCD signal changes to low, it also means that the connection line is down.

When the DCD changes, the NPort will immediately send an e-mail or send an SNMP trap.

DSR changed

The DSR (Data Set Ready) signal has changed, also indicating that the data communication equipment's power is off. For example, a DSR change to high also means that the DCE is powered ON. If the DSR signal changes to low, it also means that the DCE is powered off.

When the DSR changes, the NPort will immediately send an e-mail or send an SNMP trap.

Mail

| Setting | Factory Default | Necessity |
|-----------------|-----------------|-----------|
| Enable, Disable | Disable | Optional |

This feature helps the administrator manage the NPort. The NPort sends mail to pre-defined mail boxes when the enabled events—such as Cold start, Warm start, Authentication failure, etc.—occur. To configure this feature, click on the event type box.

Trap

| Setting | Factory Default | Necessity |
|-----------------|-----------------|-----------|
| Enable, Disable | Disable | Optional |

This feature helps the administrator manage the NPort. The NPort send SNMP Trap to a pre-defined SNMP Trap server when the enabled events—such as Cold start, Warm start, Authentication failure, etc.—occur. To configure this feature, you need to click on the event type box.

**ATTENTION**

DCD changed and **DSR changed** event only supported by NPort 5410/5450/5450I models, which have these two signals.

Monitor

Monitor Line

Click on **Line** under **Monitor** to show the operation mode and status of each connection (IPx), for each of the four serial ports.

| Line | | | | | | |
|------|---------------|--------|-----|-----|-----|--|
| Port | OP Mode | IP1 | IP2 | IP3 | IP4 | |
| 1 | Real COM Mode | Listen | | | | |
| 2 | Real COM Mode | Listen | | | | |
| 3 | Real COM Mode | Listen | | | | |
| 4 | Real COM Mode | Listen | | | | |

Monitor Async

Click on **Async** under **Monitor** to show the current status of each of the four serial ports.

| Async | | | | | | | |
|-------|-------|-------|------------|------------|-----|-----|-----|
| Port | TxCnt | RxCnt | TxTotalCnt | RxTotalCnt | DSR | CTS | DCD |
| 1 | 0 | 0 | 0 | 0 | OFF | OFF | OFF |
| 2 | 0 | 0 | 0 | 0 | OFF | OFF | OFF |
| 3 | 0 | 0 | 0 | 0 | OFF | OFF | OFF |
| 4 | 0 | 0 | 0 | 0 | OFF | OFF | OFF |

Monitor Async-Settings

Click on **Async Setting** under **Monitor** to show the run-time settings for each of the four serial ports.

| Async-Settings | | | | | | | | | |
|----------------|-----------|-----------|-----------|--------|--------|---------|----------|---------|--|
| Port | Baud rate | Data bits | Stop bits | Parity | FIFO | RTS/CTS | XON/XOFF | DTR/DSR | |
| 1 | 115200 | 8 | 1 | None | Enable | OFF | OFF | OFF | |
| 2 | 115200 | 8 | 1 | None | Enable | OFF | OFF | OFF | |
| 3 | 115200 | 8 | 1 | None | Enable | OFF | OFF | OFF | |
| 4 | 115200 | 8 | 1 | None | Enable | OFF | OFF | OFF | |

Change Password

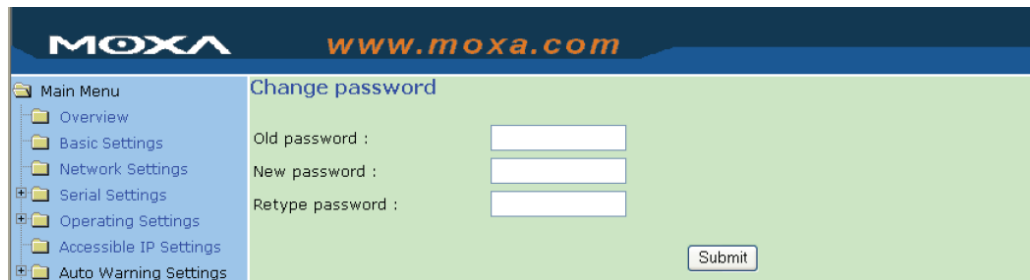

Input the “Old password” and “New password” to change the password. Leave the password boxes blank to erase the password. In this case, the NPort will not have password protection.



ATTENTION

If you forget the password, the **ONLY** way to configure the NPort is by using the Reset button on the NPort's casing to “Load Factory Default.”

Remember to export the configuration file using Windows Administrator when you finish the configuration. By using the Import function of Windows Administrator, your configuration can be re-loaded into the NPort after using “Load Factory Default.” Refer to Chapter 6 for more details about the Export and Import function.

Load Factory Default

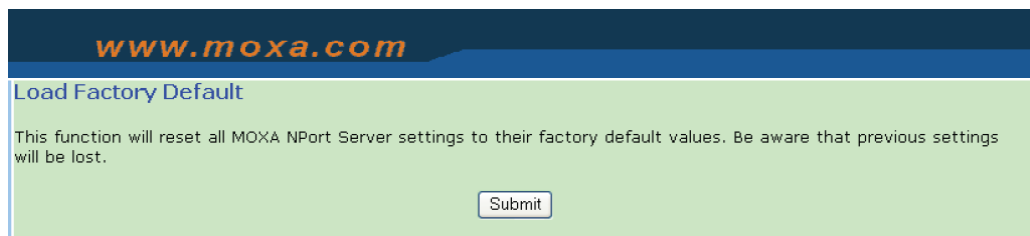

This function will reset all of the NPort's settings to the factory default values. Be aware that previous settings will be lost.

6

Configuring NPort Administrator

The following topics are covered in this chapter:

- ❑ **Overview**
- ❑ **Installing NPort Administrator**
- ❑ **Configuration**
 - Broadcast Search
 - Specify by IP Address
 - Password Protection
 - Unlock Password Protection
 - Configuring the NPort 5400
 - Web Console
 - Upgrading the Firmware
 - Export Configuration
 - Import Configuration
- ❑ **Monitor**
- ❑ **Port Monitor**
- ❑ **COM Mapping**
 - On-line COM Mapping
 - Off-line COM Mapping
- ❑ **IP Address Report**
- ❑ **Automatic Message Log**

Overview

NPort Administration Suite is an integrated software suite that bundles NPort Administrator and the IP Serial Library, providing everything you need to manage, monitor, and modify your NPort 5400 from a remote location.

With NPort Administrator, you can easily install and configure your NPort 5400 device server over the network. Five different sets of functions are provided to ease the installation process: Configuration, Monitor, Porting Monitor, COM Mapping, and IP Address Report. The following sections describe the installation procedures and details.

Installing NPort Administrator

1. Once the Setup program starts running, click on **Next** when the **Welcome** window opens to proceed with the installation.

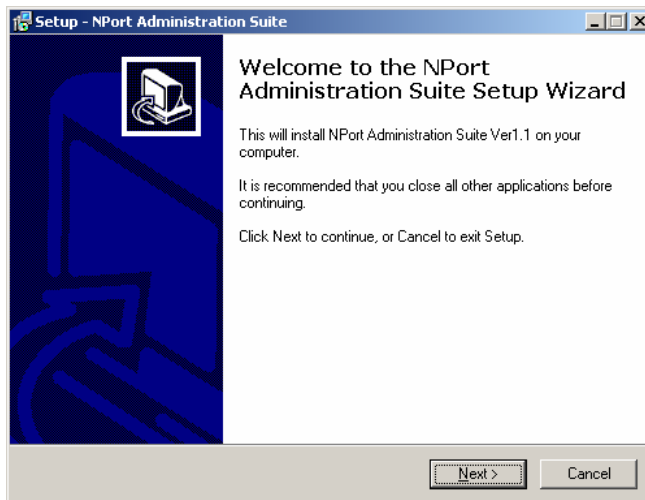

2. Click on **Next** to install program files in the default directory, or select an alternative location.

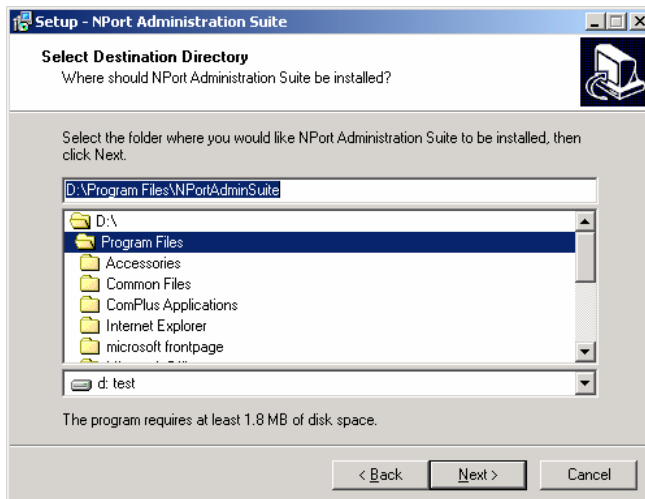

- Click on **Next** to install the program using the default program name, or select a different name.

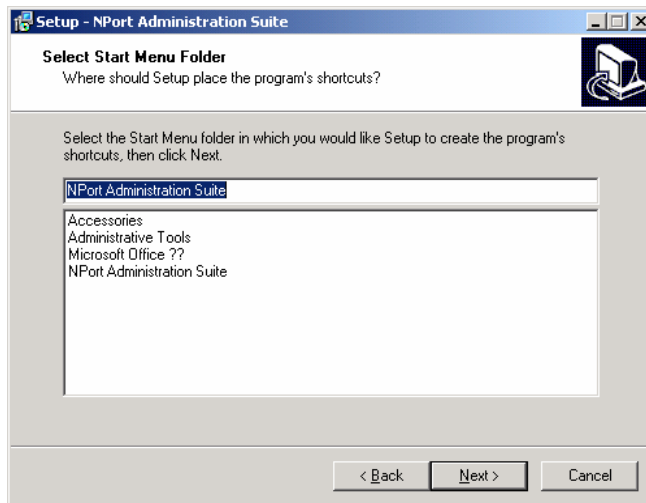

- Click on **Install** to proceed with the installation.

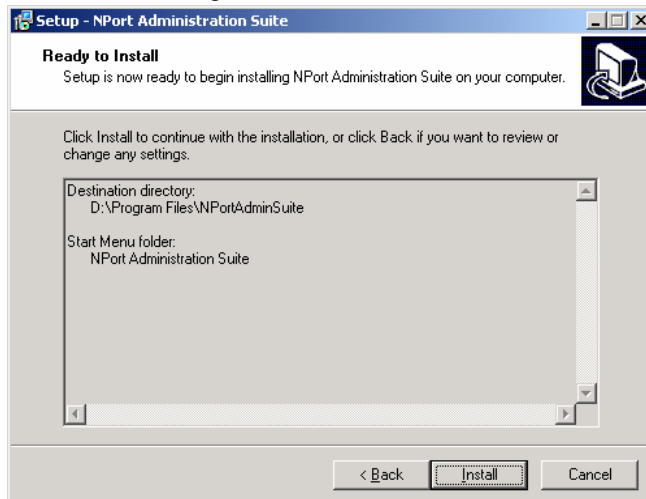

- The **Installing** window reports the progress of the installation.

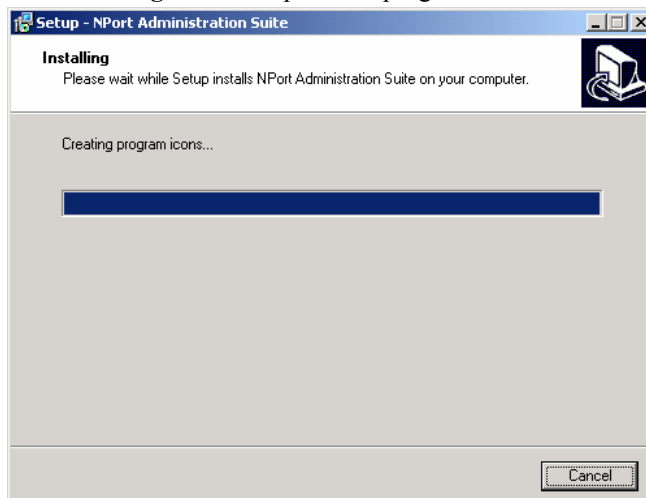

- Click on **Next** to proceed with the installation.

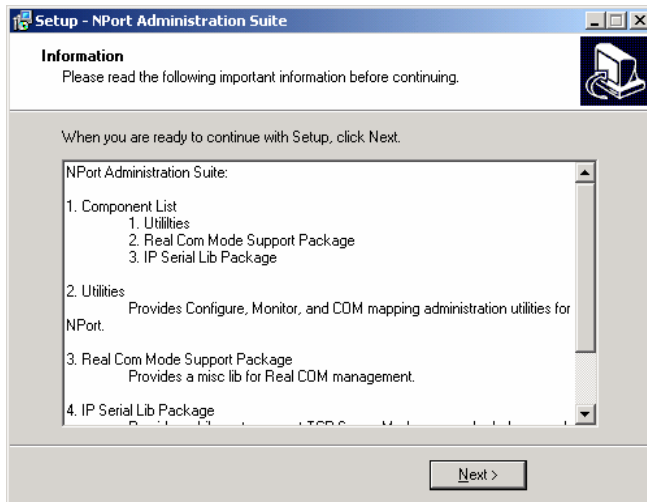

- Click on **Finish** to complete the installation of NPort 5400 Administration Suite.

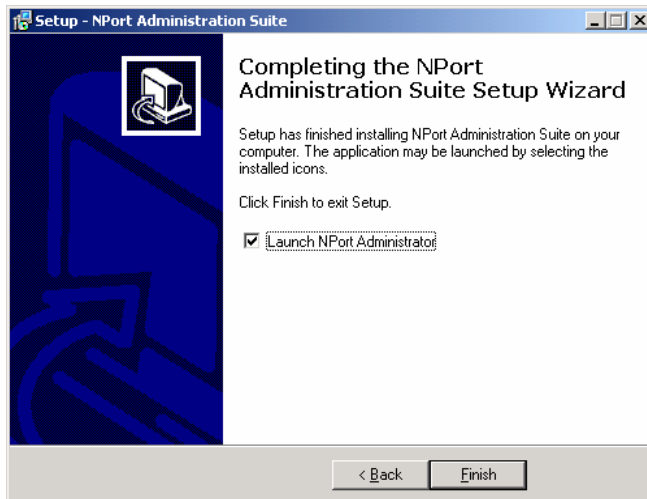

Configuration

The Administrator-Configuration window is divided into four parts.

- The top section contains the function list and online help area. (Windows NT does not support this .chm file format.)
- The five Administrator function groups are listed in the left section.
- A list of NPort 5400 serial device servers, each of which can be selected to process user requirements, is displayed in the right section.
- The activity Log, which displays messages that record the user's processing history, is shown in the bottom section.

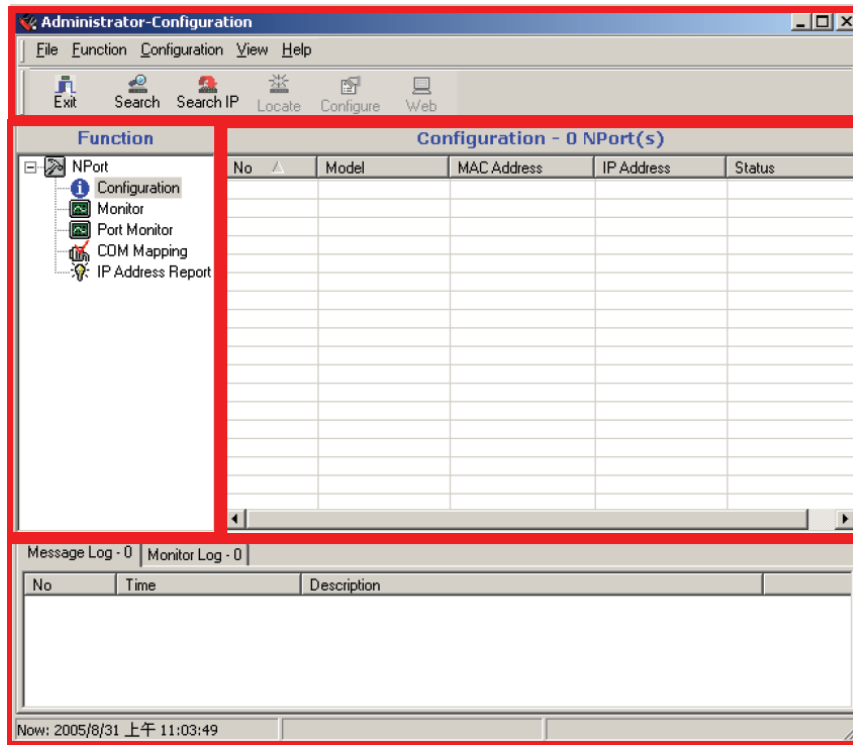

Broadcast Search

The **Broadcast Search** function is used to locate all NPort 5400s that are connected to the same LAN as your computer. Since the Broadcast Search function searches by MAC address and not IP address, all NPort 5400s connected to the LAN will be located, regardless of whether or not they are part of the same subnet as the host.

1. Click the Search icon. The **Broadcast Search** window will open and display the Model, IP Address, MAC Address, and Progress of the search for that particular device.

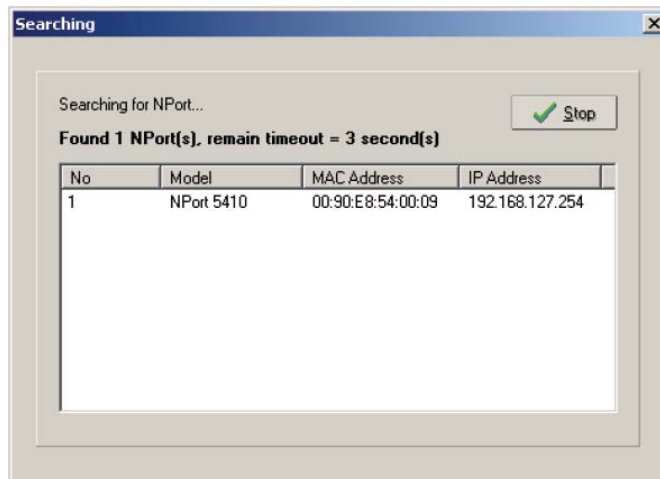

- When the search is complete, the Broadcast Search window will close, and a list of device servers that were located will be displayed in the right pane of the Administrator window. You can modify the IP address of the NPort 5400 after it has been located by the Broadcast Search function. If more than one server is found on the network, refer to the MAC address sticker on your server(s) to determine which server(s) you wish to configure. To configure a device server, place the cursor over the row displaying that device server's information, and then double click the left mouse button.

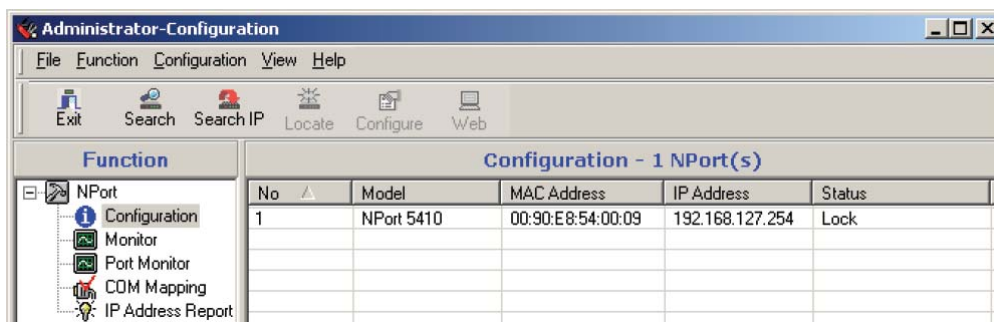

ATTENTION

Before modifying the NPort 5400's configuration, use **Broadcast Search** to locate all NPort 5400s connected to the LAN, or use **Specify by IP Address** to locate a particular NPort 5400.

Specify by IP Address

If you know the current IP address of the NPort that you wish to configure, you can add it to the list directly by using the Specify by IP Address function.

Password Protection

The NPort 5400 can be password-protected to prevent unauthorized configuration changes. The six possible protection states are described below. Note that the term "Fixed" is borrowed from the standard fixed IP address networking terminology.

When using Broadcast Search to obtain a list of NPort device servers on the network, each device server will show a status of either Lock, Unlock or Blank.

Lock

The NPort 5400 is password protected, "Broadcast Search" was used to locate it, and the password has not yet been entered from within the current Administrator session.

Unlock

The NPort 5400 is password protected, "Broadcast Search" was used to locate it, and the password has been entered from within the current Administrator session. Henceforth during this Administrator session, activating various utilities for this NPort 5400 will not require re-entering the server password.

Blank

The NPort 5400 is not password protected, and "Broadcast Search" was used to locate it.

Fixed

The NPort 5400 is not password protected, and "Search by IP address" was used to locate it.

Lock Fixed

The NPort 5400 is password protected, "Specify by IP address" was used to locate it, and the password has not yet been entered from within the current Administrator session.

Unlock Fixed

The NPort 5400 is password protected, “Specify by IP address” was used to locate it, and the password has been entered from within the current Administrator session. Henceforth during this Administrator session, activating various utilities for this NPort 5400 will not require re-entering the server password.

Unlock Password Protection

If the NPort 5400 is password protected, as indicated by a status of “Lock”, you will receive the following error when you attempt to modify the configuration. You will not be able to use the right click method to open the configuration page.

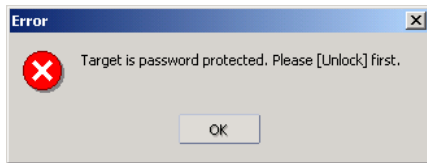

In this case, proceed as follows to “Unlock” the device server.

1. Select the NPort 5400 with “Lock” status, click the right mouse button, and then select **Unlock**.

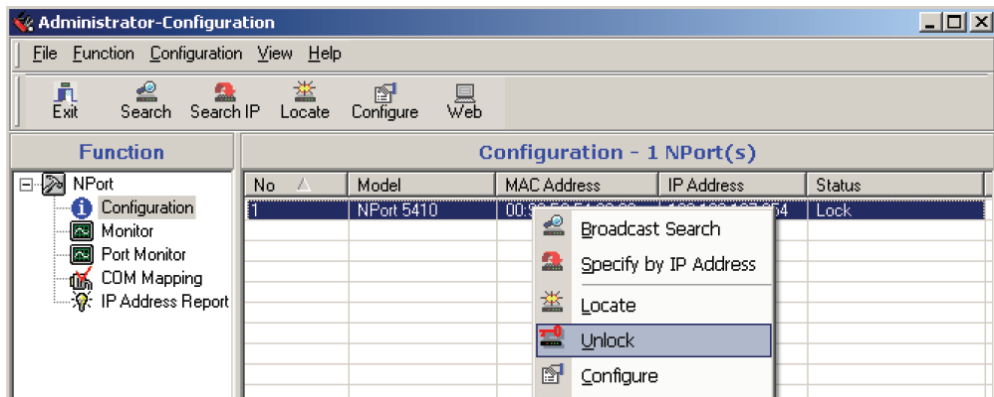

2. Input the password and then click on **OK**.

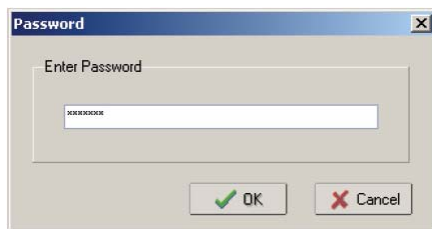

3. NPort Administrator will display an “Unlock ok” message.



- The "Lock" status will change to "Unlock," and the Administrator utility will keep this NPort 5400 in the Unlock status throughout this Administrator session.

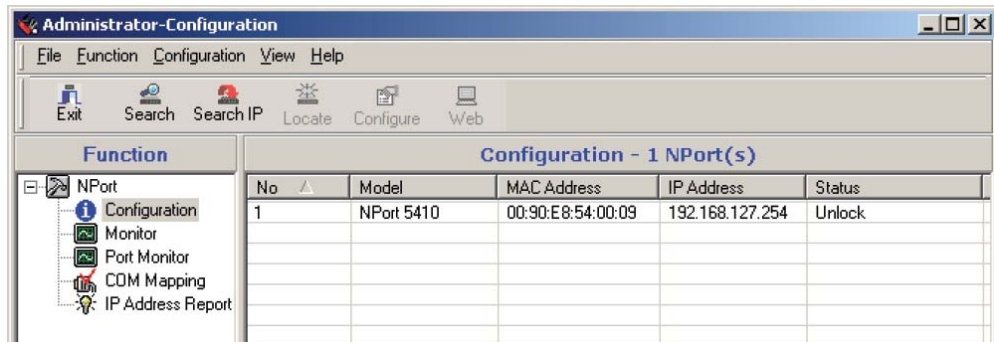

Configuring the NPort 5400

In this section, we illustrate how to access the NPort 5400's configuration utility. You should first make sure that you can connect over the network from your computer to the NPort 5400.

- To start NPort Administrator, click on **Start → NPort Administration Suite → NPort Administrator**.

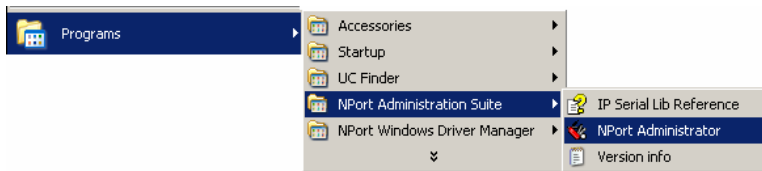

- Unlock the NPort 5400 you wish to configure if it is password protected. Right click on the NPort 5400 and select **Configure** to start the configuration.

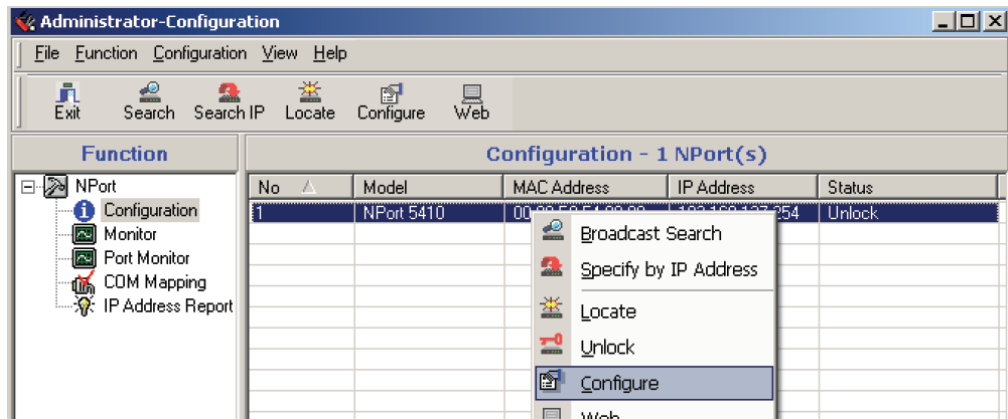

- The progress bar shows that Administrator is retrieving configuration information from the specific NPort 5400.

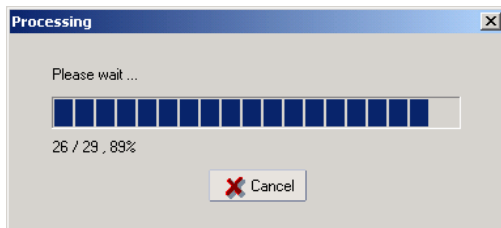

4. Refer to Chapter 5 for each parameter's function definition. To modify the configuration, you must first click in the modify box to activate the parameter setting box. For example, click on the middle modify box.

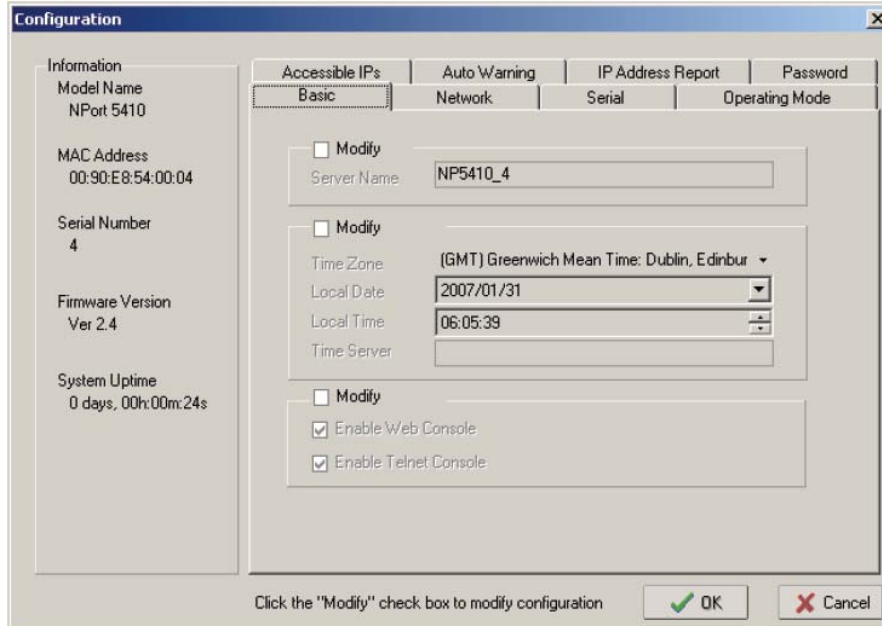

5. You will now be able to modify **Time Zone, Local Date, Local Time, and Time Server.**

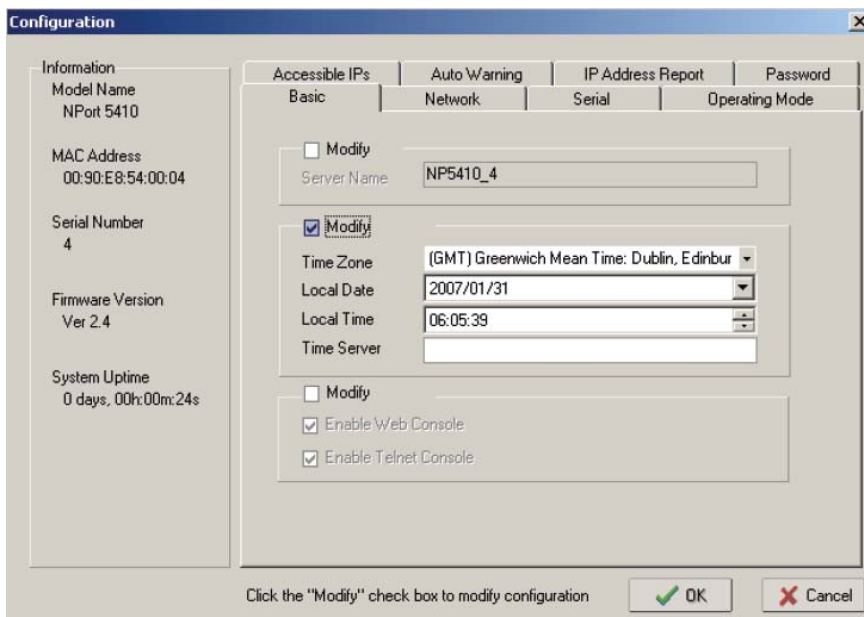

ATTENTION

You can simultaneously modify the configurations of multiple NPort 5400s that are of the same model.

To select multiple NPort 5400s, hold down the Ctrl key when selecting additional NPort 5400s, or hold down the Shift key to select a group of NPort 5400s.

Web Console

You can use the web console to configure device servers in the NPort 5000 line. The web console can be opened from NPort Administrator by right clicking on the device server and selecting the **Web** function.

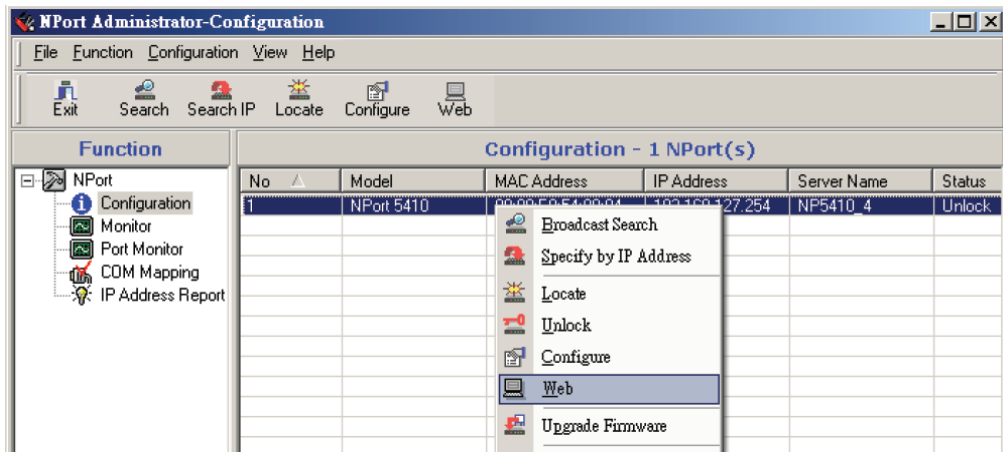

Upgrading the Firmware

Follow these steps to upgrade the firmware of an NPort 5400.

1. To start NPort Administrator, click on **Start → NPort Administration Suite → NPort Administrator**.

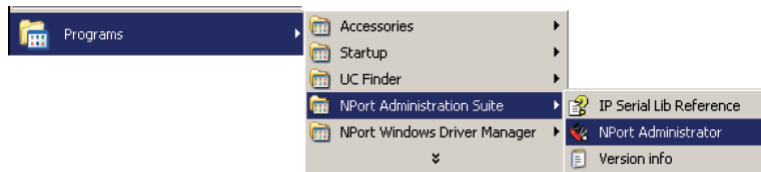

2. Unlock the NPort 5400 you wish to configure if it is password protected. Right click on a specific NPort 5400 and select the **Upgrade Firmware** function to start upgrading the firmware.

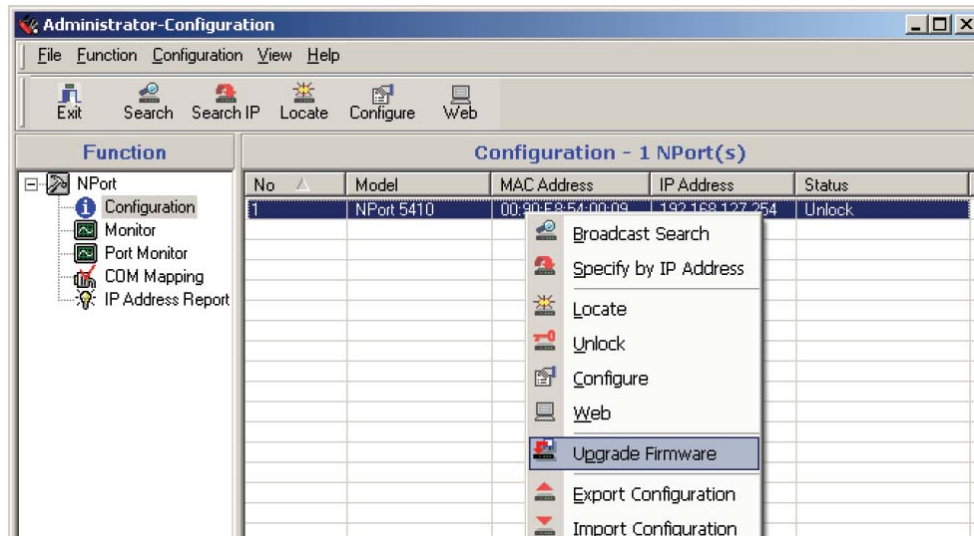

3. Select the correct ROM file to download.

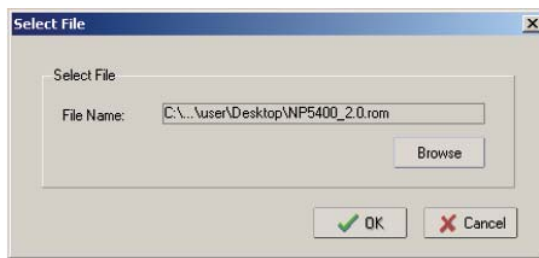

4. Wait while the Upgrade Firmware action is processed.

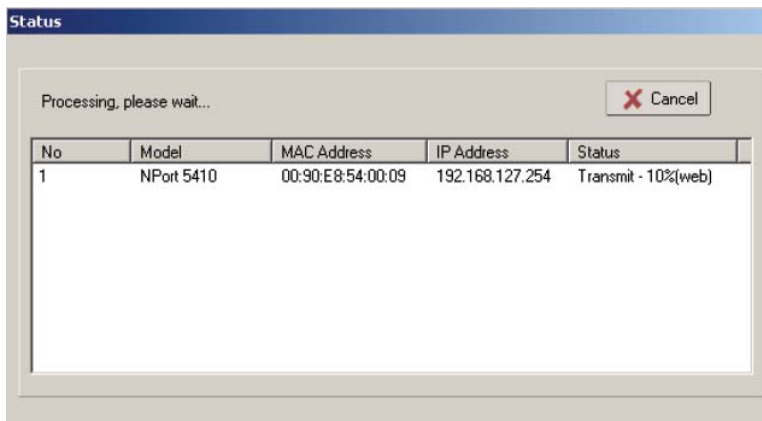

ATTENTION

You can simultaneously upgrade the firmware of multiple NPort 5400s that are of the same model.

To select multiple NPort 5400s, hold down the Ctrl key when selecting an additional NPort 5400, or hold down the Shift key to select a block of NPort 5400s.

Export Configuration

To export the configuration of an NPort 5400, right click on the NPort 5400, select Export Configuration, and then follow the onscreen instructions. The Export Configuration function is a handy tool that can be used to produce a text file containing the current configuration of a particular NPort 5400.

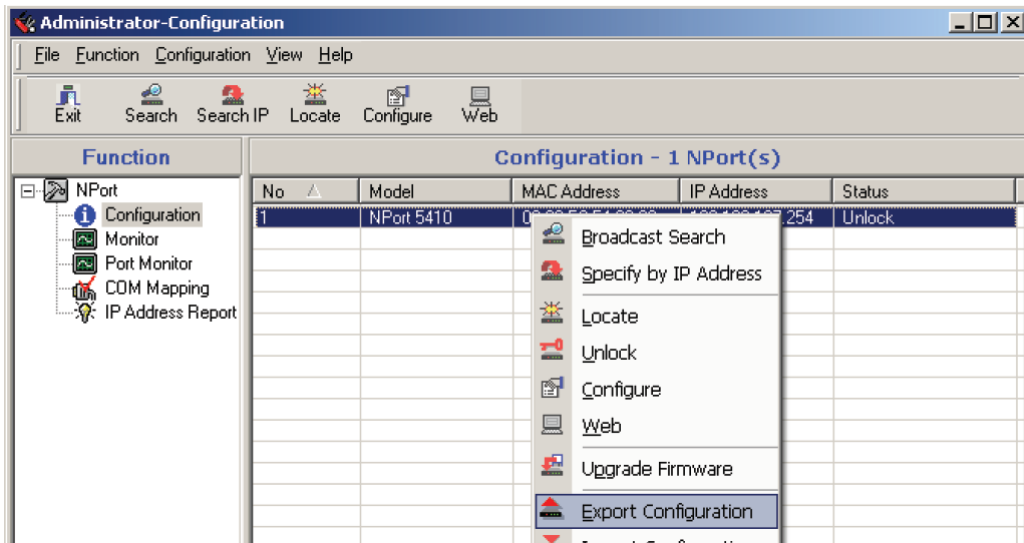

Import Configuration

The Import Configuration function is used to import an NPort 5400 configuration from a file into one or more of the same model NPort 5400. To import a configuration, first select the target servers, click the right mouse button, and then select Import Configuration. Follow the onscreen instructions to locate the configuration file and start downloading the file.

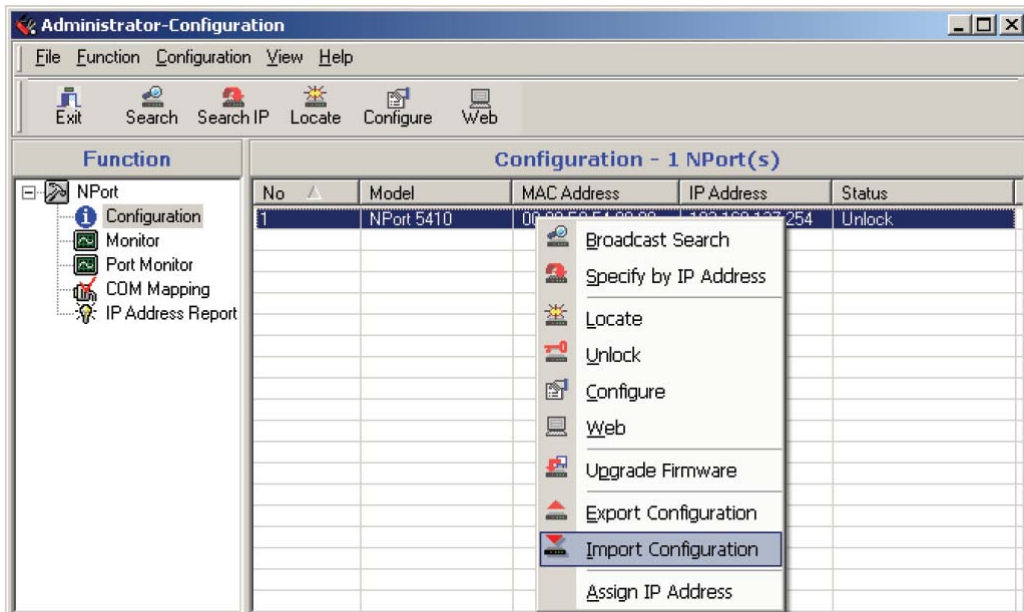

ATTENTION

You can simultaneously import the same configuration file into multiple NPort 5400s that are of the same model.

To select multiple NPort 5400s, hold down the Ctrl key when selecting an additional NPort 5400, or hold down the Shift key to select a block of NPort 5400s.

Monitor

Use one of the following two methods to start the Monitor function.

Broadcast Search → Monitor → Add Target

1. With Configuration selected under Function, use Broadcast Search to locate all NPort device servers on your LAN.

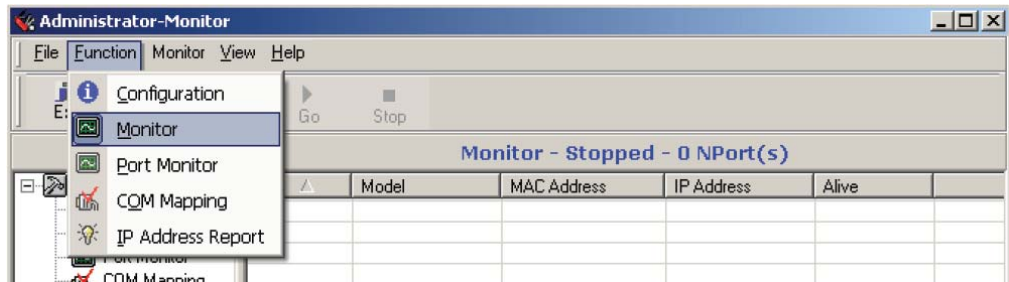

2. Next, click on **Monitor → Add Target**, select your targets from the list, and then click on **OK**.

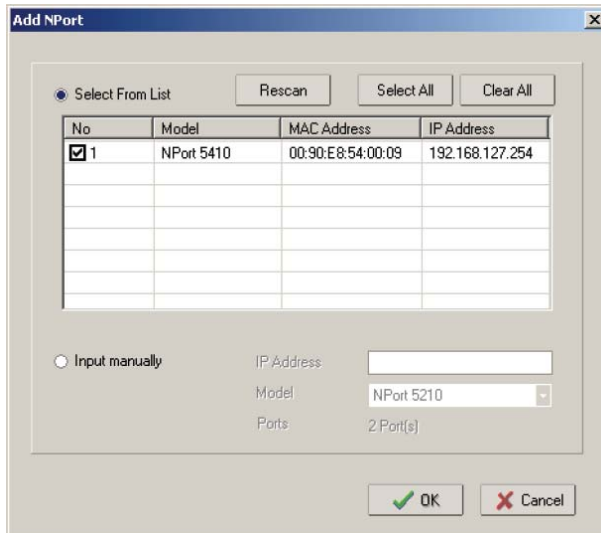

Monitor → Add Target → Rescan

1. Click on **Monitor** under **Function**.

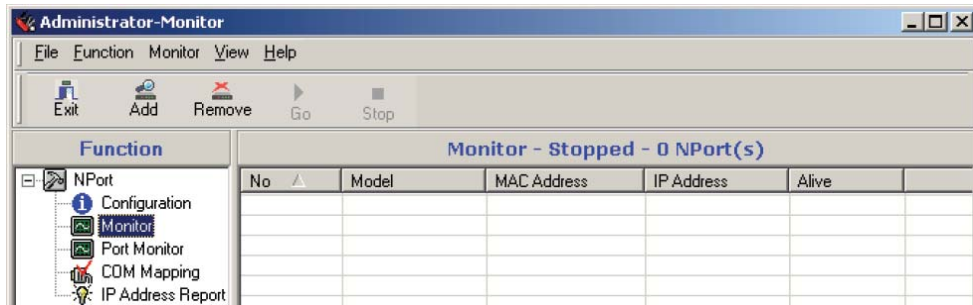

2. Click on **Monitor → Add Target** from the menu bar, or click the right mouse button and select **Add Target**.

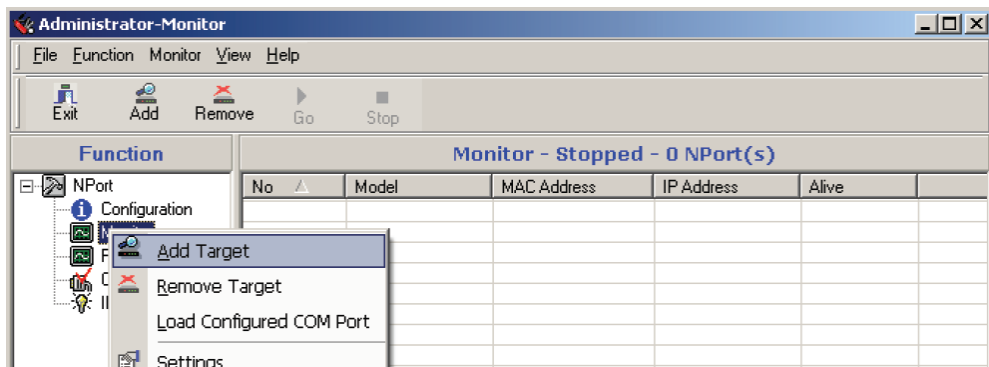

3. Click on **Rescan**.

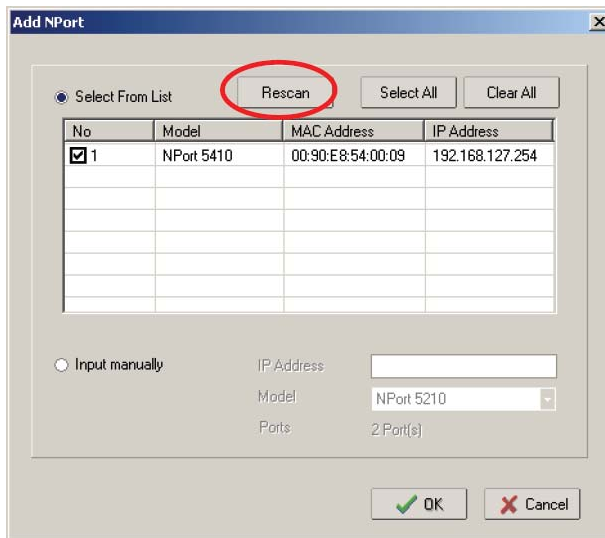

4. Select your targets from the list, and then click on **OK**.

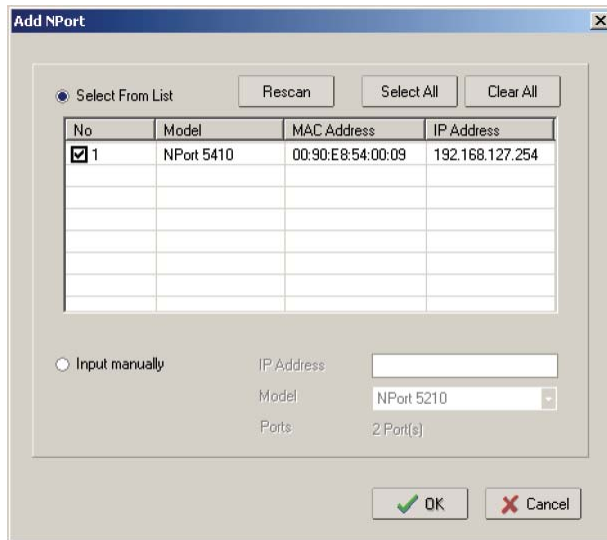

Monitor → Load Configured COM Port

Use the Load Configured COM Port function to monitor device servers that are being used for COM Mapping.

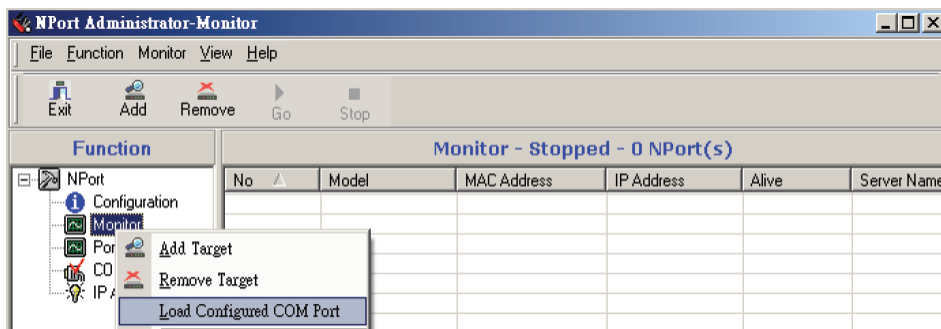

Once the Monitor function is running:

1. The NPort 5400 list will appear on the Monitor screen.

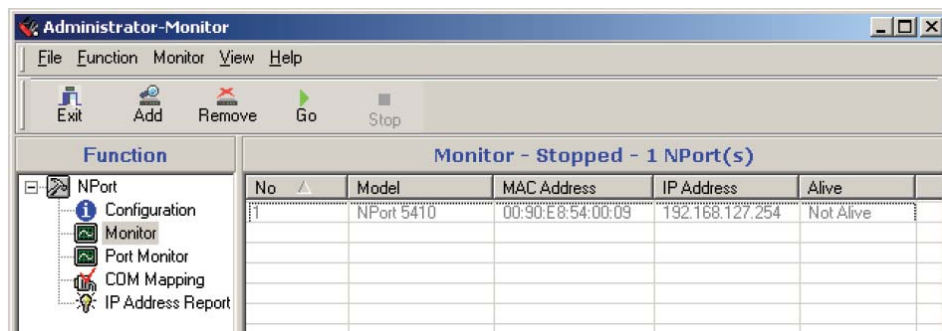

2. Right click the panel and select **Settings**.

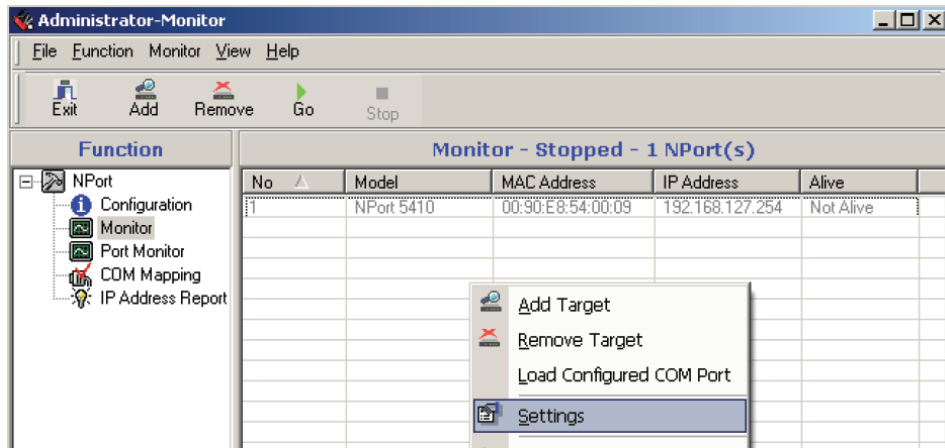

3. Select or de-select **Monitor Items**. Use the single arrowhead buttons to move highlighted items from one box to the other. Use the double arrowhead buttons to move all items in one box to the other.

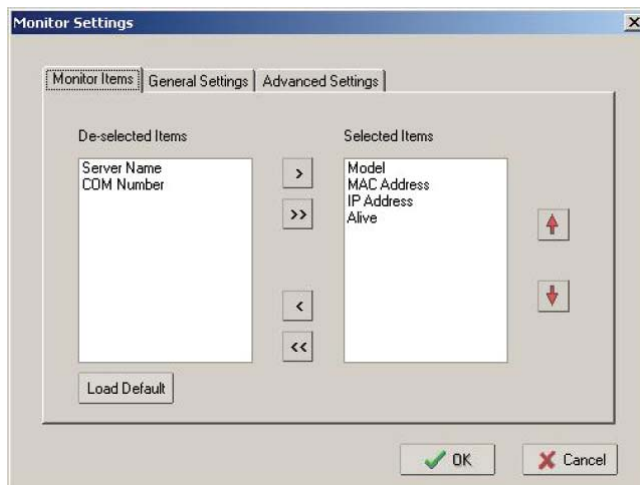

4. Select a **Refresh Rate** (the default is 3 seconds) on the General Settings page.

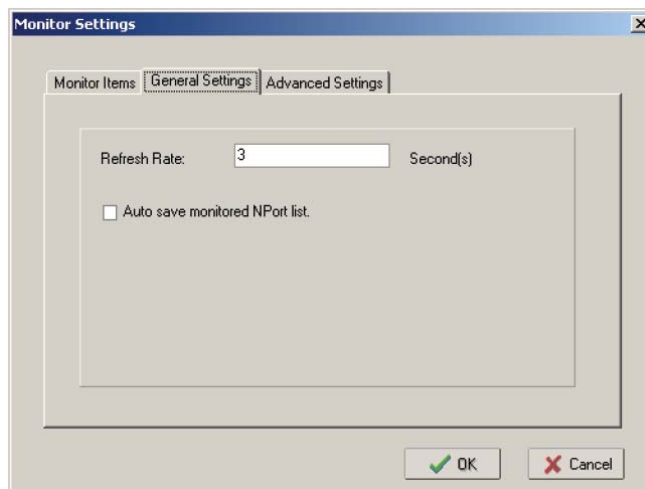

- On the **Advanced Settings** page, select **Display warning message for new event** and/or **Play warning music for new event**. In the second case, you must enter the path to the WAV file that you want to be played. "New event" means that one of the NPort 5400s in the monitor is "Alive" or "Not Alive," or has lost connection with the Monitor program.

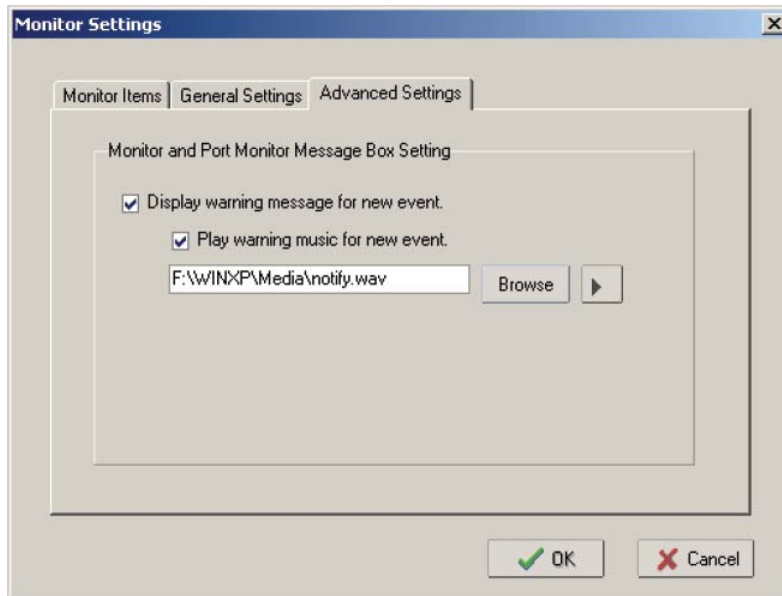

- Right click in the NPort 5400 list section and select **Go** to start monitoring the NPort 5400.

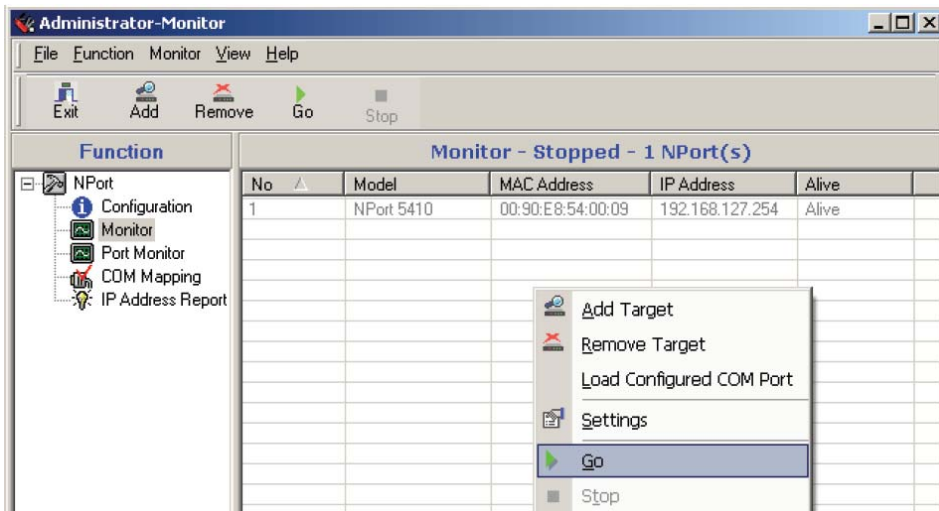

- For this example, the NPort 5400s shown in the list will be monitored.

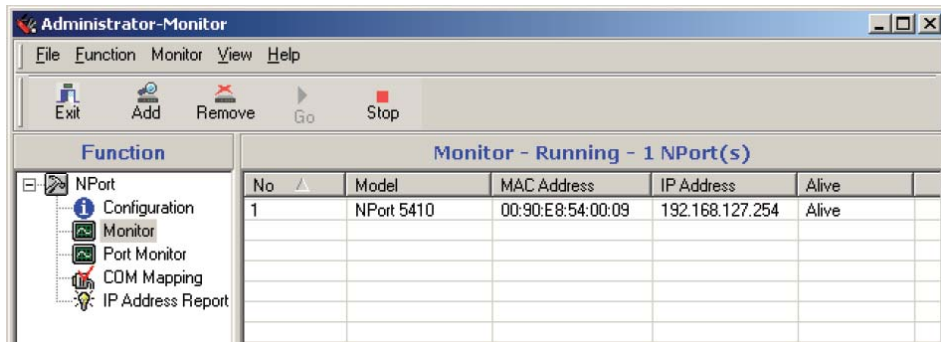

- When one of the NPort 5400s loses connection with the Monitor program, a warning alert will display automatically. The warning music will be played at the same time.

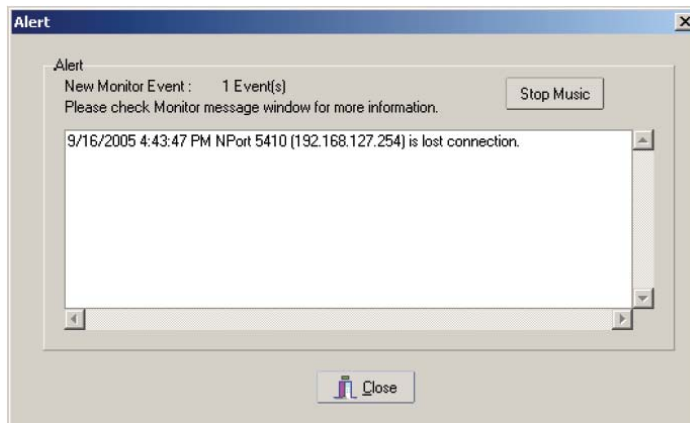

- In the Monitor screen, you can see that the NPort 5400s that are "Not Alive" are shown in red color.

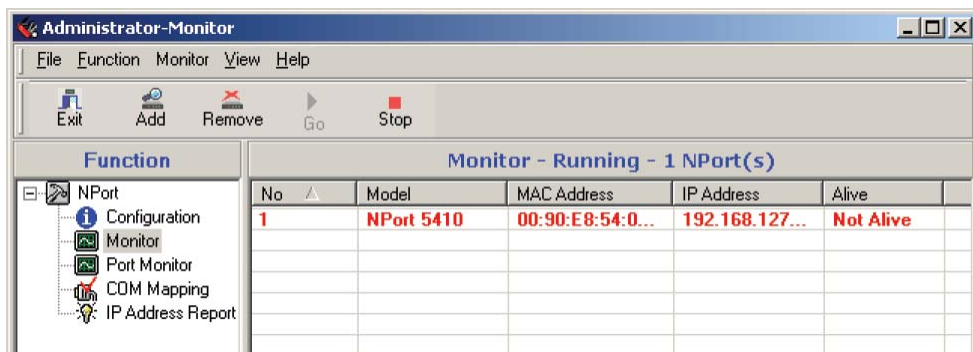

- If the NPort 5400 gets reconnected, a warning will be displayed to remind the user that the NPort 5400 is now "Alive."

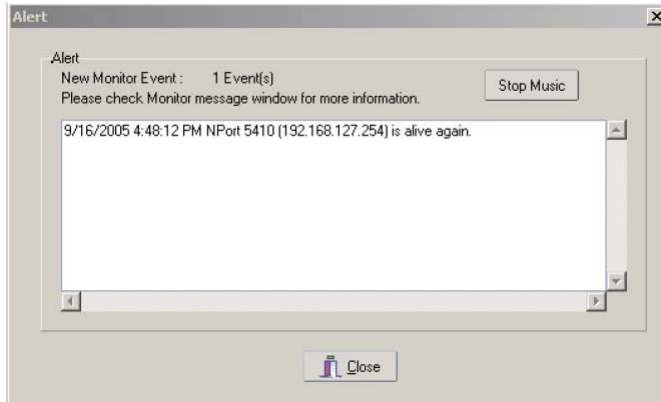

- The NPort 5400s that were reconnected, and are now "Alive," will be shown in black color.

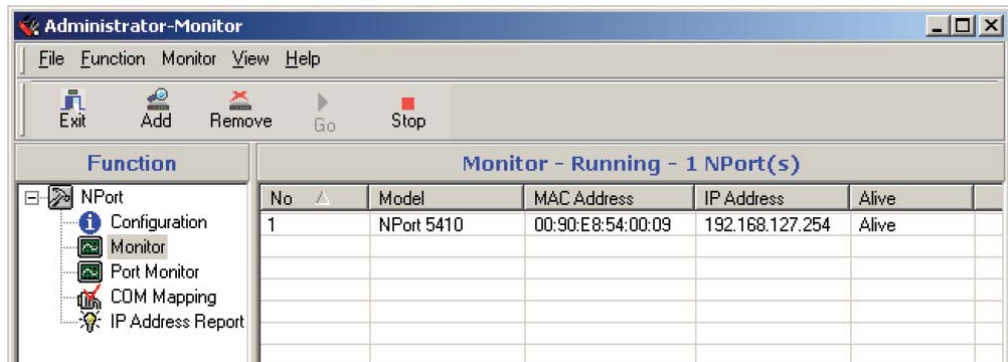

Port Monitor

The process described here is the same as in the previous "Monitor" section. The only difference is that you can select more items under Port Monitor than under Monitor.

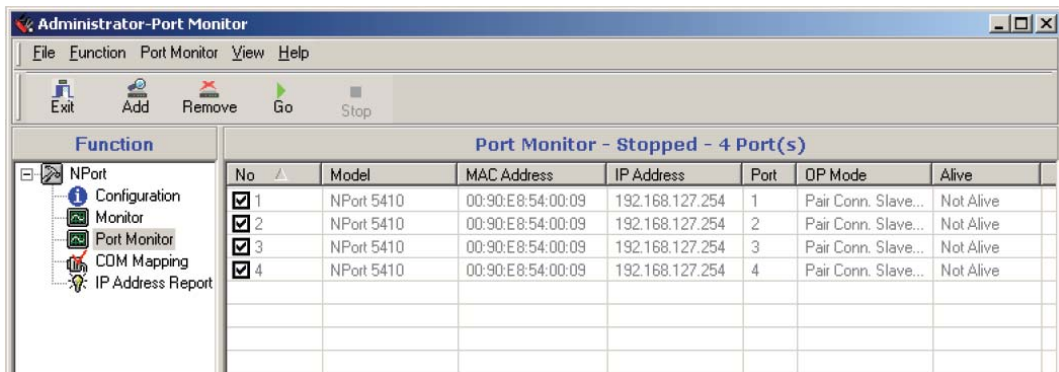

Select or de-select **Monitor Items**. Use the single arrowhead buttons to move highlighted items from one box to the other. Use the double arrowhead buttons to move all items in one box to the other.

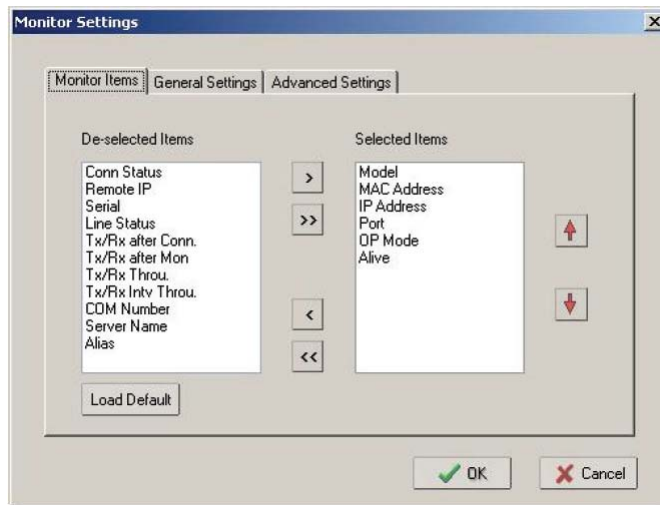

COM Mapping

Windows Administration Suite comes with Windows Real COM drivers. After you install NPort 5400 Administration Suite, there are two ways to set up the NPort 5400 serial port as your host's remote COM port.

The first way is with **On-line COM Mapping**. On-line COM Mapping will check to make sure that the NPort 5400 is connected correctly to the network, and then install the driver on the host computer.

The second way is with **Off-line COM Installation**, without first connecting the NPort 5400 to the network. Off-line COM Mapping can decrease the system integrator's effort by solving different field problems. Via off-line installation, users can first process software installation for the host, and then install the NPort 5400 to different fields.

Use the following procedure to map COM ports:

1. **On-line COM Mapping:**
 Connect the NPort 5400 to the network → Set the NPort 5400 to the proper IP address → Map COMs to your host → Apply Change.
2. **Off-line COM Mapping:**
 Map COMs to your host → Apply Change → Connect the NPort 5400 to the network → Configure the NPort 5400's IP address.

On-line COM Mapping

1. **Broadcast Search** for NPort 5400s on the network.

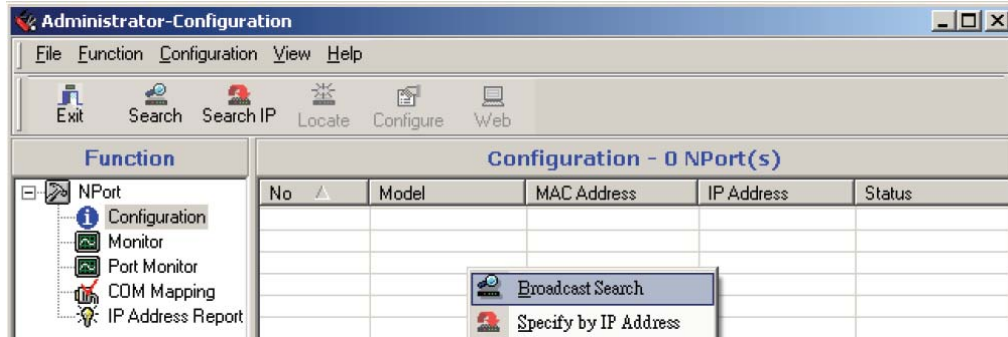

2. Select the **COM Mapping** function group.

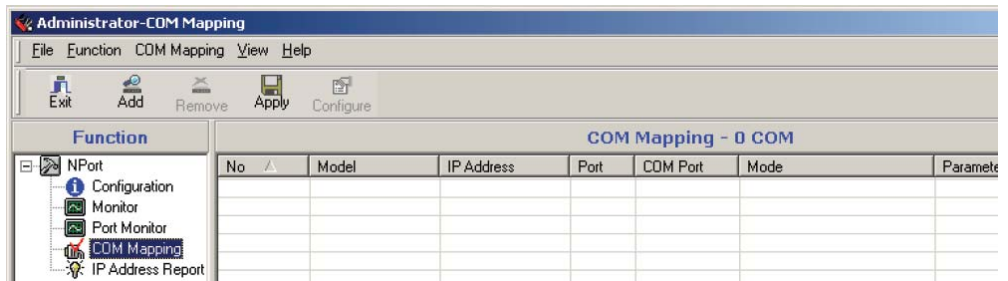

3. Add the target to which you would like to map COM ports.

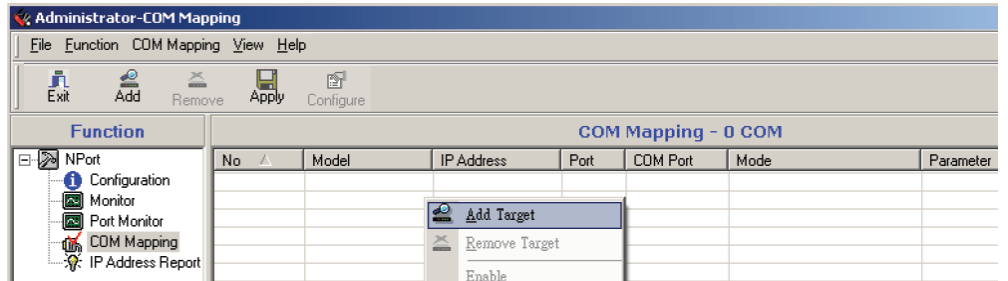

- The NPort 5400 list that appears is the list generated by the previous Broadcast Search. Select the NPort 5400 to which you would like to map COM ports.

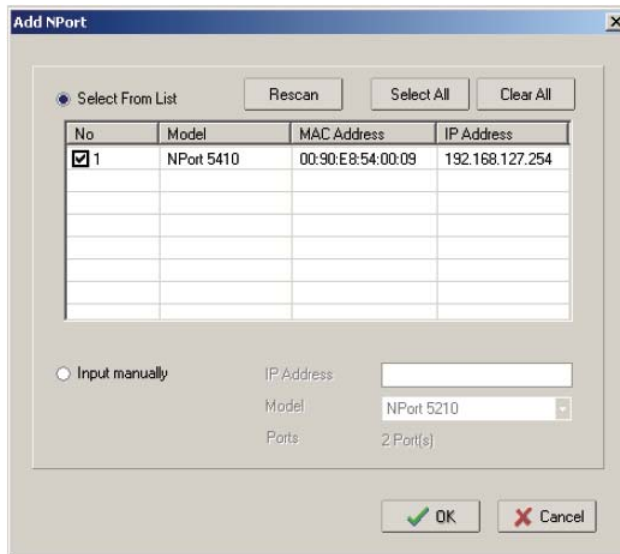

- Select **COM Settings** to modify COM No., default setting, etc.

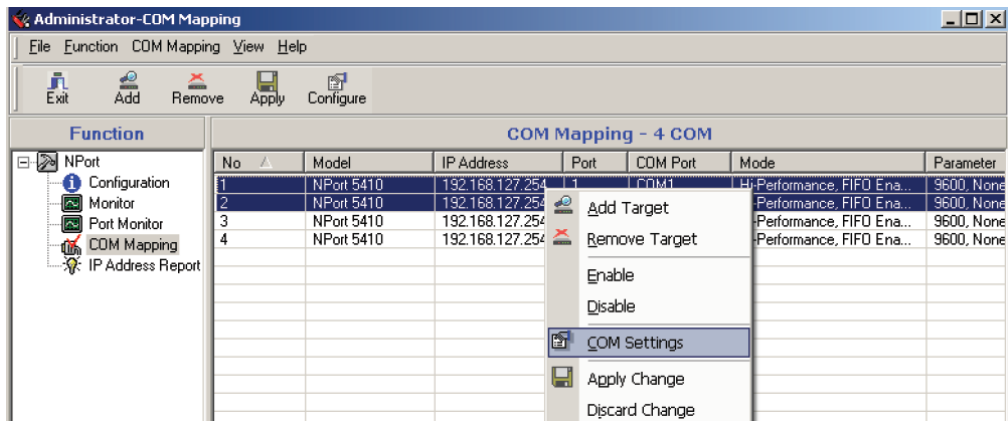

- Select the **COM Number**.
This assigns a COM Number that your PC host can use to access the NPort's serial port. Available COM Numbers and status are shown in the drop-down list. COM Numbers that are already being used by the system, including COM Numbers that are already mapped to NPort serial ports, will be shown as "in use". COM Numbers that have been selected for mapping will be shown as "assigned" if the changes have not been applied yet. The currently selected COM Number for the NPort serial port will be shown as "current".

If you select multiple serial ports or multiple device servers, remember to check the "Auto Enumerating" function. COM Numbers will then be assigned automatically in numerical order, starting from the COM Number that you select.

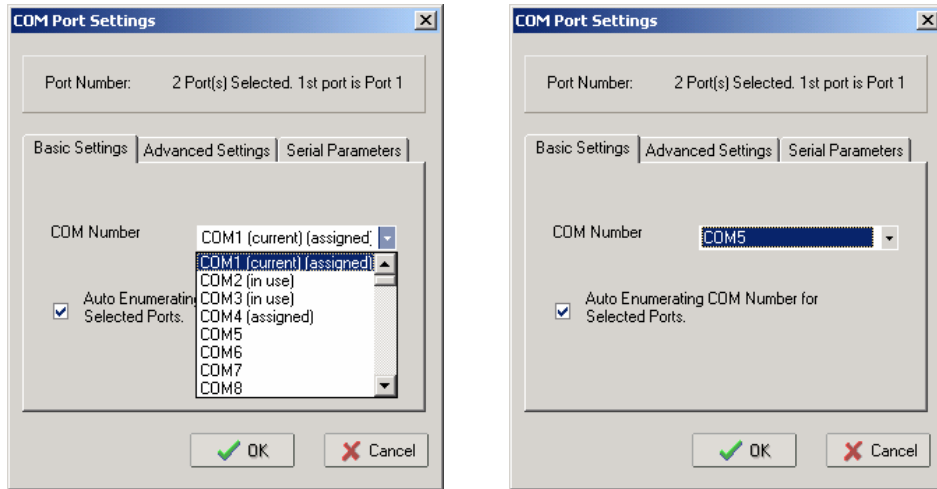

7. **Hi-performance** mode is the default for Tx mode. If the driver completes sending data out to the NPort 5400, the driver will respond “Tx Empty” to the program.
Under **Classical mode**, the driver will not notify the user’s program that Tx is completed until all Tx data has been sent out from the NPort 5400. This mode will cause lower throughput. If you want to ensure that all data is sent out before further processing, classical mode is recommended.

Enable/Disable Tx/Rx FIFO. If disabled, the NPort 5400 will send one byte each time the Tx FIFO becomes empty; and an Rx interrupt will be generated for each incoming byte. This will result in a faster response and lower throughput. If you want to use XON/XOFF flow control, we recommend setting FIFO to Disable.

Network Timeout is used when the COM port is opened. Since the COM port is on the network rather than physically attached to the PC host, there can be some lag when communicating with the serial device. The Network Timeout field allows you to set the number of milliseconds before an operation will time out. The default value is 5000 milliseconds, and between 500 and 20000 milliseconds can be entered.

Fast Flush (only flush local buffer)

- We have added one optional Fast Flush function to Moxa’s new NPort Real COM driver. **NPort Administrator Suite for 2G NPort** adds it after version 1.2.
- For some applications, the user’s program will use the Win32 “PurgeComm()” function before it reads or writes data. With our design, after the program uses this Purge Comm() function, the NPort driver will keep querying the NPort’s firmware several times to make sure there is really no data queued in the NPort firmware buffer, rather than just flushing the local buffer. This kind of design is used because of some special considerations. However, it might take more time (on the order of several hundred milliseconds) than a native COM1, because it needs to work via Ethernet. That’s why the native COM ports on the motherboard can work fast with this function call, but the NPort requires much more time. In order to accommodate other applications that require a faster response time, the new NPort driver implements a new “Fast Flush” option. Note that by default, this function is disabled.
- To begin with, make sure there are some “PurgeComm()” functions being used in your application program. In this kind of situation, you might find that your NPort exhibits a much poorer operation performance than when using the native COM1 port. Once you have enabled the “Fast Flush” function, you can check to see if there has been an improvement in performance.

- By default, the optional “Fast Flush” function is disabled. If you would like to enable this function, from the “NPort Administrator,” double click on the COM ports that are mapped to the NPort, and then select the “Fast Flush” checkbox. You should find that when “Fast Flush” is enabled, the NPort driver will work faster with “PurgeComm().”

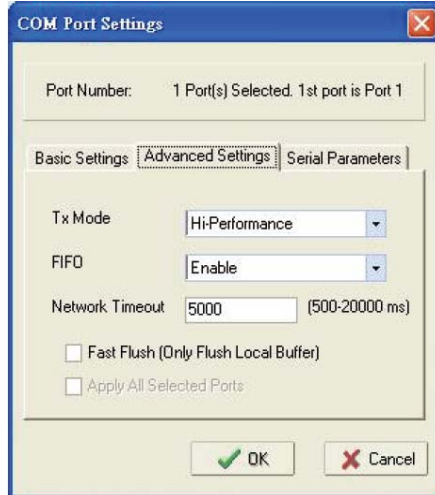

8. The Serial Parameter settings shown here are the default settings when the NPort 5400 is powered on. However, the program can redefine the serial parameters to different values after the program opens the port via Win 32 API.

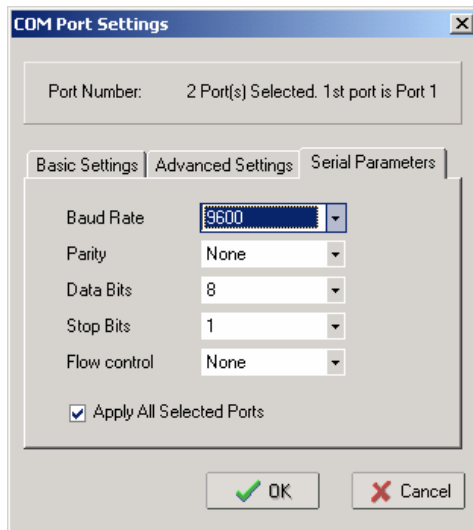

- After setting the COM Mapping, remember to select **Apply Change** to save the information in the host system registry. The host computer will not have the ability to use the COM port until after **Apply Change** is selected.

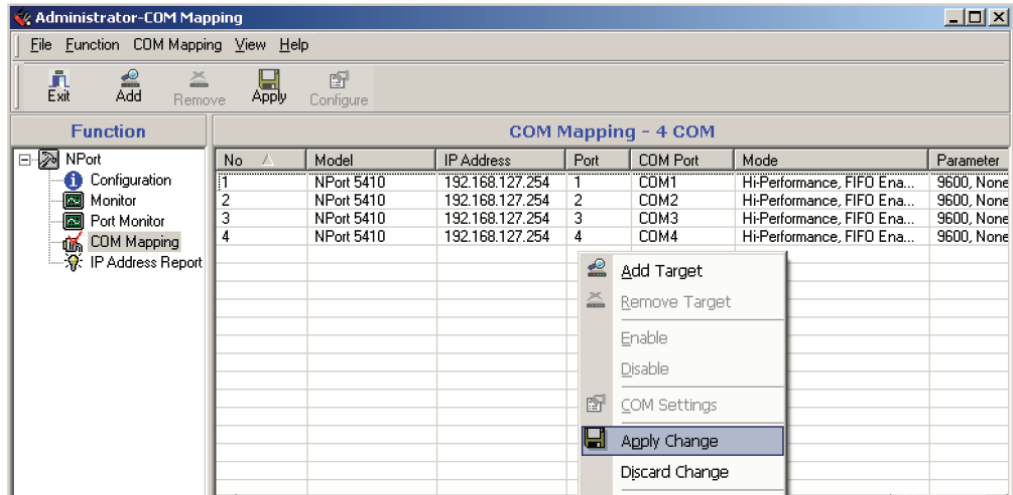

- Select **Discard Change** to tell Administrator NOT to save the COM Mapping information to the host.

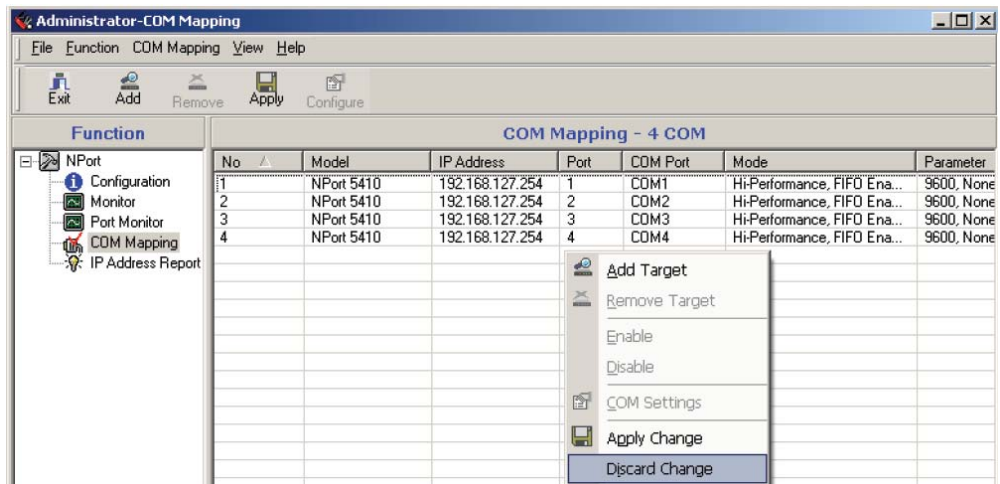

- To save the configuration to a text file, select **Export COM Mapping**. You will then be able to import this configuration file to another host and use the same COM Mapping settings in the other host.

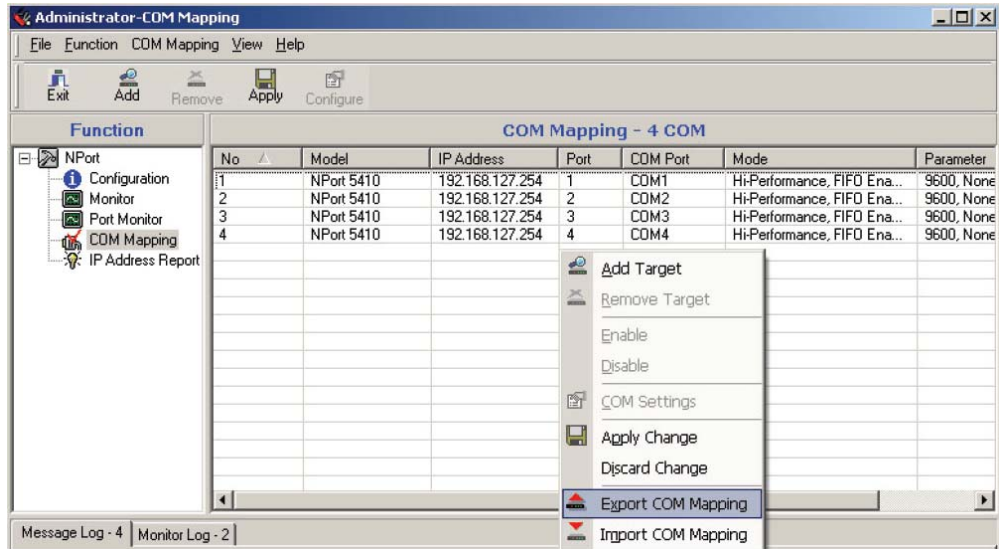

Off-line COM Mapping

- Add a target by inputting the IP address and selecting the Model Name without physically connecting the NPort 5400 to the network.

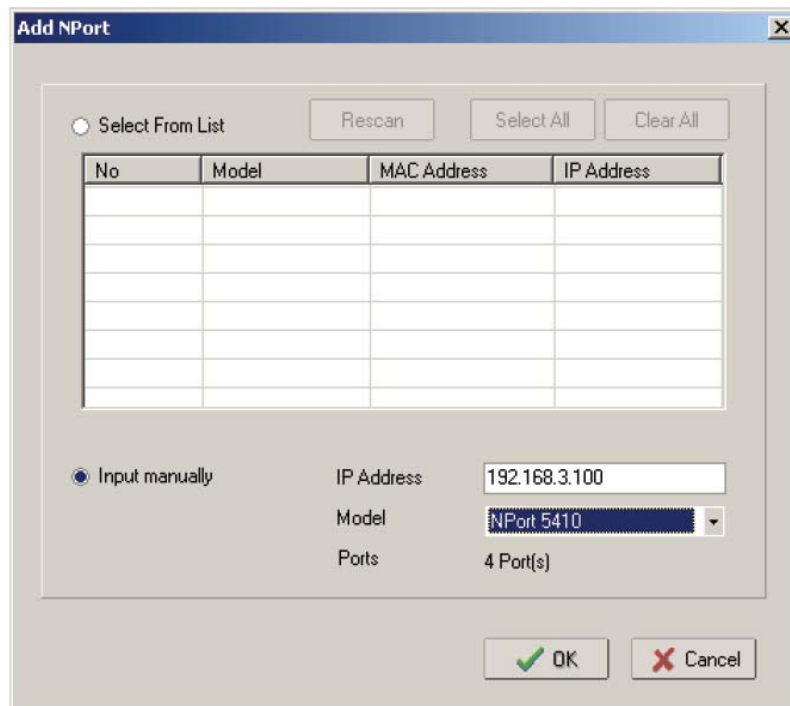

2. Modify the port settings as needed.

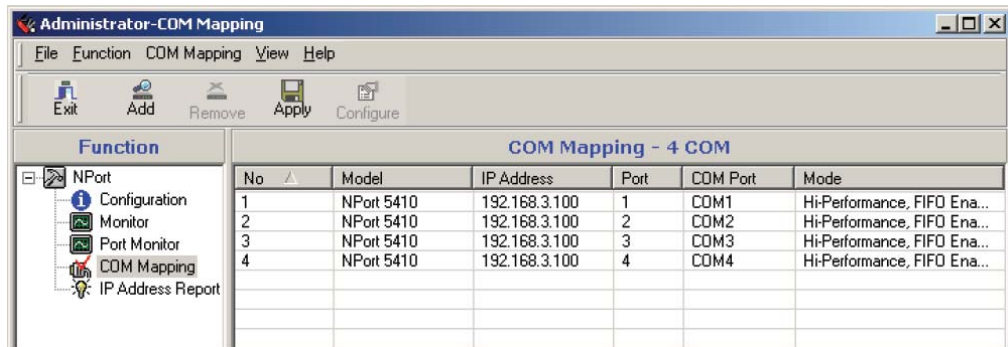

3. Right click in the NPort list section and select **Apply Change**.

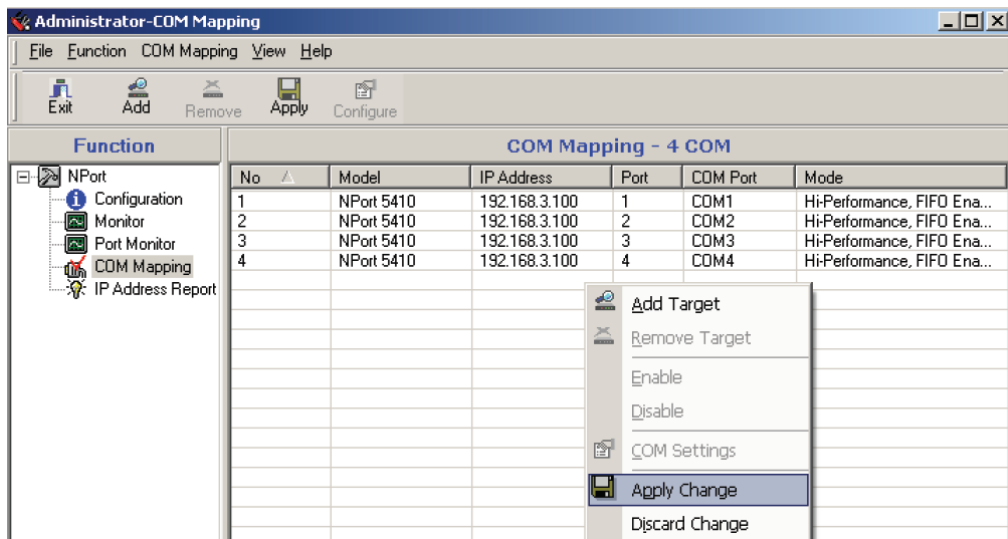

IP Address Report

When the NPort 5400 is used in a dynamic IP environment, users must spend more time with IP management tasks. To make things easier, the NPort 5400 can periodically report its IP address to the IP location server, in case the address has changed. The IP location server is the host PC on which you installed the NPort Administration Suite.

1. Configure the NPort 5400 with Dynamic IP settings (DHCP, BOOTP, or DHCP/BOOTP). Assign the remote Auto IP report server's IP address and UDP port.



2. Select the **IP Address Report**, and click the right mouse button to select Settings.

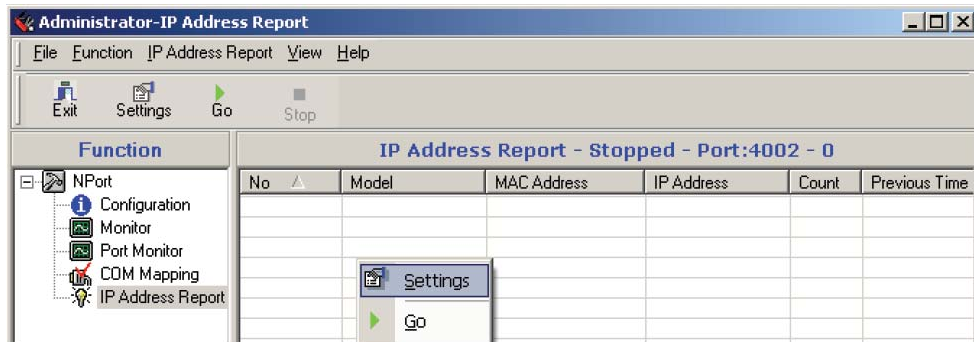

3. Configure the Local Listen Port to be the same as the NPort 5400's "Auto report to UDP port" setting.



- Click **Go** to start receiving the Auto IP address report from the NPort 5400.

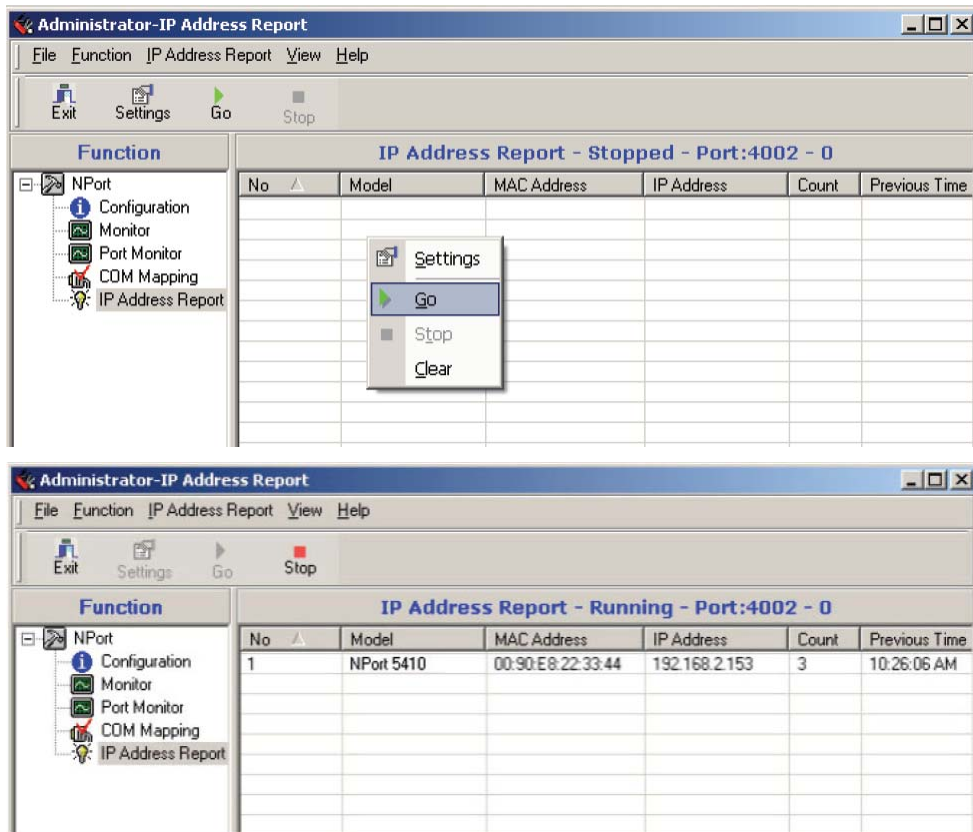

Automatic Message Log

Since NPort Administrator may be used in a multi-user environment, it is possible for a user to modify a device server's configuration with other users unaware of the changes. Accordingly, NPort Administrator keeps a record of activity messages in the Message Log, located in the installation file directory. When a user closes NPort Administrator, the log will be saved as "file message_x.log", where 'x' cycles in value from 0 to 9.

7

NPort CE Driver Manager for Windows CE

The following topics are covered in this chapter:

- ❑ **Overview**
- ❑ **Installing NPort CE Driver Manager**
- ❑ **Using NPort CE Driver Manager**

Overview

NPort CE Driver Manager is designed for use with NPort 5000 serial ports that are set to Real COM mode. The software manages the installation of drivers that allow you to map unused COM ports on your PC to serial ports on the NPort 5000. These drivers are designed for use with Windows CE 5.0/6.0. When the drivers are installed and configured, devices that are attached to serial ports on the NPort 5000 will be treated as if they were attached to your PC's own COM ports.

Installing NPort CE Driver Manager

1. Copy "NPortCab.cab" to Windows CE and start to install driver by double clicking on it.
2. Click on "OK" to complete the installation when the following screen appears.

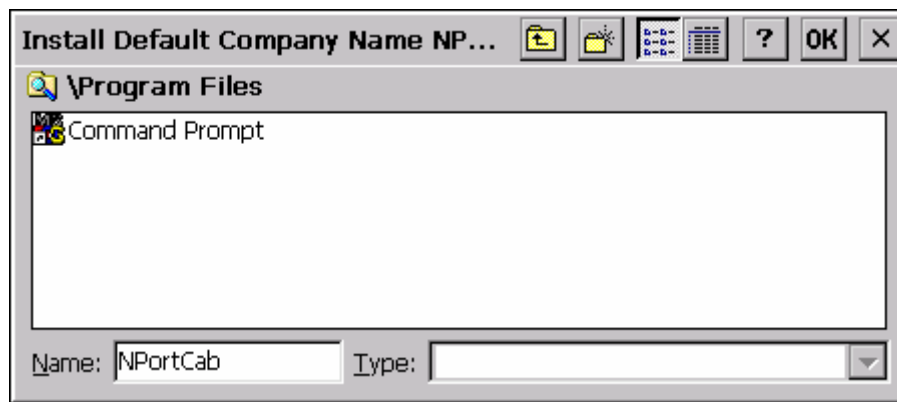

3. Driver installation is now complete and the "NPortCab.cab" icon disappear from the screen. This is normal when installing drivers in Windows CE.

Using NPort CE Driver Manager

After you install NPort CE Driver Manager, you can set up the NPort's serial ports as remote COM ports for your Windows CE. Make sure that the serial port(s) on your NPort are set to Real COM mode when mapping COM ports with NPort CE Driver Manager.

1. Go to **Start → Programs → NPort CE Driver Manager**.

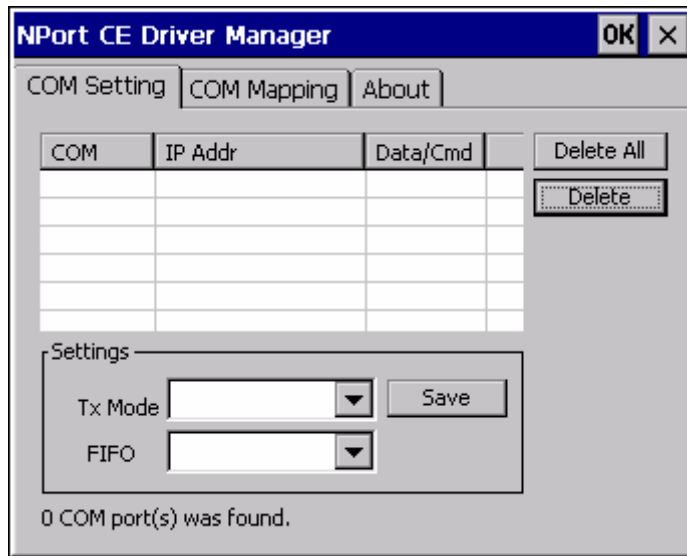

2. Click on the **COM Mapping** page and then the “Search” button to scan for NPort servers.

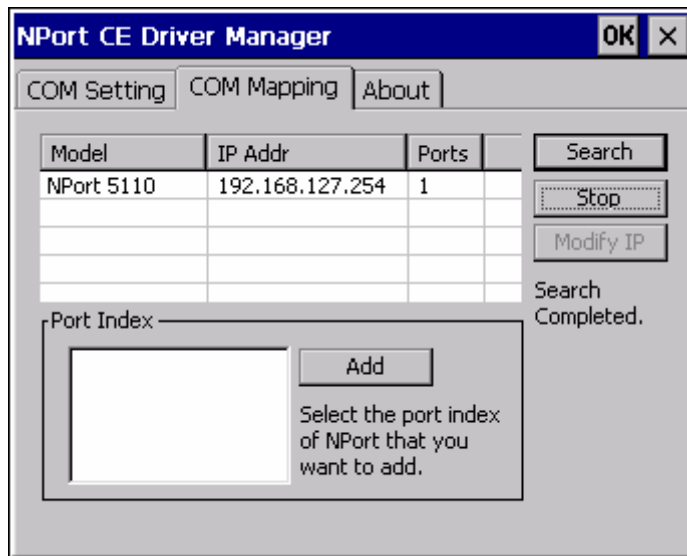

3. All NPort servers that were located will appear in the NPort CE Driver Manager window. Click on the server whose COM ports you would like to map to and then select the port index. Note that multiple selections are allowed.
4. Select the port(s) at the Port Index and then click on the "Add" button to map to the COM Port(s).

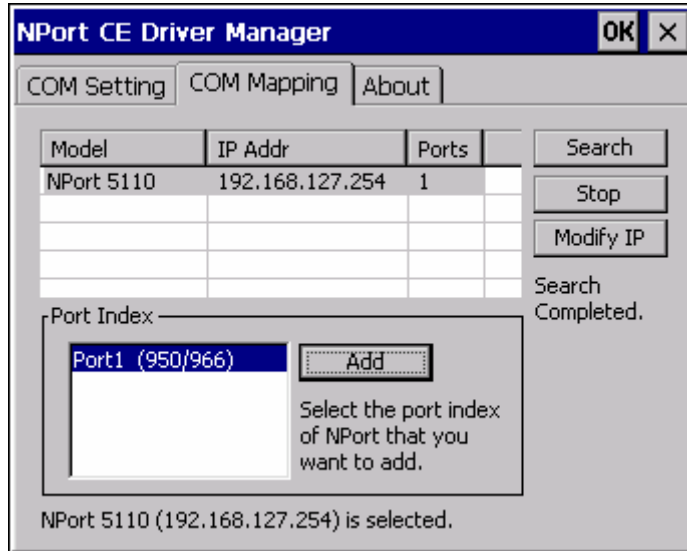

5. Return to the **COM Setting** page. You should be able to see the newly mapped COM Port(s).

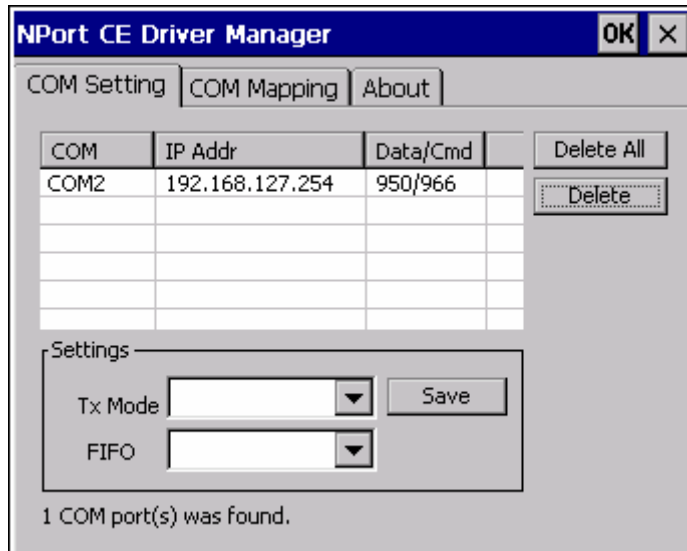

6. To configure the settings for a particular COM Port, select the row of the desired port, and then modify the setting in the "Settings" panel, as shown below.

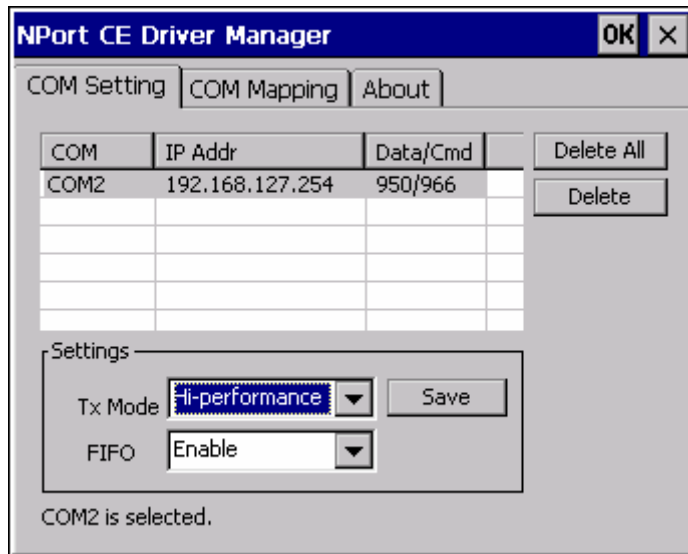

Tx Mode

“Hi-Performance” is the default for Tx mode. After the driver sends data to the NPort server, the driver immediately issues a “Tx Empty” response to the program. Under “Classical mode,” the driver will not send the “Tx Empty” response until after confirmation is received from the NPort server’s serial port. This causes lower throughput. Classical mode is recommended if you want to ensure that all data is sent out before further processing.

FIFO

If FIFO is disabled, the NPort server will transmit one byte each time the Tx FIFO becomes empty, and an Rx interrupt will be generated for each incoming byte. This will result in a faster response and lower throughput.

8

IP Serial LIB

The following topics are covered in this chapter:

- ❑ **Overview**
- ❑ **IP Serial LIB Function Groups**
- ❑ **Example Program**

Overview

What is IP Serial Library?

IP Serial Library is a Windows library with frequently used serial command sets and subroutines. IP Serial Library is designed to reduce the complexity and poor efficiency of serial communication over TCP/IP. For example, Telnet can only transfer data, but it can't monitor or configure the serial line's parameters.

Why Use IP Serial Library?

For programmers who are familiar with serial communication, IP Serial Library provides well-designed function calls that have the same style as Moxa's PComm Library.

IP Serial Library is amazingly simple and easy to understand. By including it in your VB, C, or Delphi programming environment, you can program your own TCP/IP application with the ability to control serial communication parameters.

NPort serial device servers use 2 TCP ports for communication between the NPort and host computer's Real COM driver. The NPort uses a data port and command port to provide pure data transfer without decode and encode. Compared to using only one TCP port to control serial communication (such as RFC 2217), IP Serial Library uses a command port to communicate with the NPort in user's program. IP Serial Library not only runs with excellent efficiency but also runs without any decode or encode problems.

How to install IP Serial Library?

IP Serial Lib comes with the NPort Administration Suite. Refer to the IPSerial directory for more detail about the function definitions.

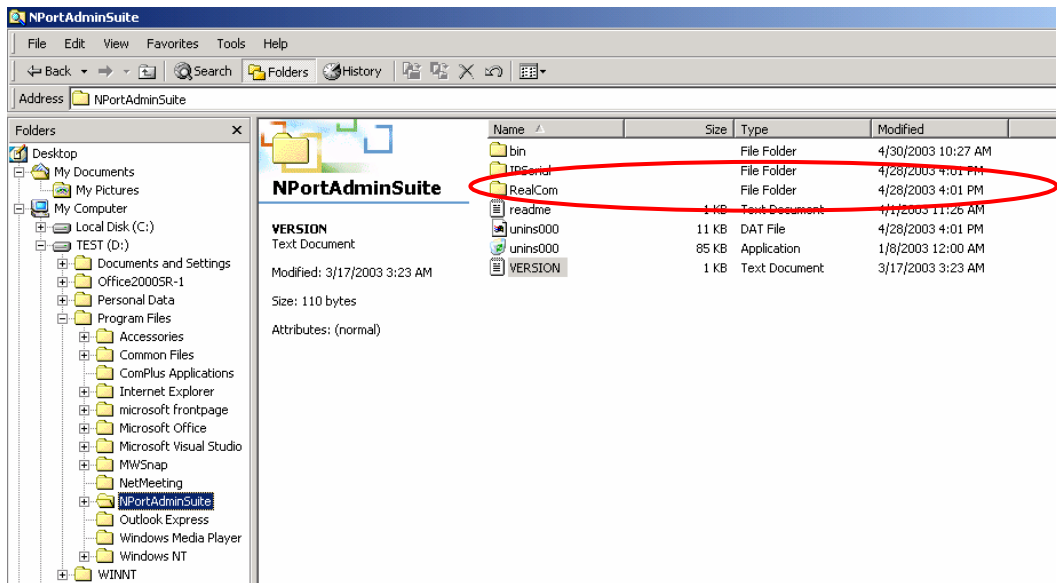

IP Serial LIB Function Groups

| Server Control | Port Control | Input/Output Data | Port Status Inquiry | Miscellaneous |
|------------------|----------------|-----------------------|---------------------|-----------------|
| nsio_init | nsio_open | nsio_read | nsio_lstatus | nsio_break |
| nsio_end | nsio_close | nsio_SetReadTimeouts | nsio_data_status | nsio_break_on |
| nsio_resetserver | nsio_ioctl | nsio_write | | nsio_break_off |
| nsio_checkalive | nsio_flowctrl | nsio_SetWriteTimeouts | | nsio_breakcount |
| | nsio_DTR | | | |
| | nsio_RTS | | | |
| | nsio_lctrl | | | |
| | nsio_baud | | | |
| | nsio_resetport | | | |

Example Program

```

char NPortip="192.168.1.10";
char buffer[255];
int port = 1;
int portid;
nsio_init();
portid = nsio_open(NPortip, port);
nsio_ioctl(portid, B9600, (BIT_8 | STOP_1 |
P_NONE) );
sleep(1000);
nsio_read(port, buffer, 200);
nsio_close(portid);
nsio_end();
/*data buffer, 255 chars */
/*1st port */
/* port handle */
/*initial IP Serial Library */
/*1st port, NPort IP=192.168.1.10 */
/*set 9600, N81 */
/* wait for 1000 ms for data */
/* read 200 bytes from port 1 */
/* close this serial port */
/* close IP Serial Library */

```

A

Pinouts and Cable Wiring

In this appendix, we cover the following topics.

- ❑ **Port Pinout Diagrams**
 - Ethernet Port Pinouts
 - Serial Port Pinouts
- ❑ **Cable Wiring Diagrams**
 - Ethernet Cables
 - Serial Cables

Port Pinout Diagrams

Ethernet Port Pinouts

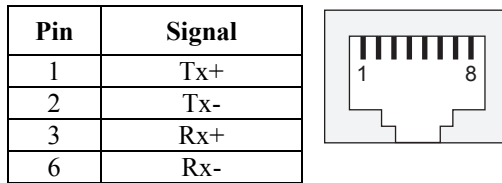

Serial Port Pinouts

DB9 Male RS-232/422/485 Port Pinouts for NPort 5410/5450/5450I

| Pin | RS-232 | RS-422/ 4-wire RS-485 | 2-wire RS-485 |
|-----|--------|--------------------------|------------------|
| 1 | DCD | TxD-(A) | --- |
| 2 | RxD | TxD+(B) | --- |
| 3 | TxD | RxD+(B) | Data+(B) |
| 4 | DTR | RxD-(A) | Data-(A) |
| 5 | GND | GND | GND |
| 6 | DSR | --- | --- |
| 7 | RTS | --- | --- |
| 8 | CTS | --- | --- |
| 9 | --- | --- | --- |

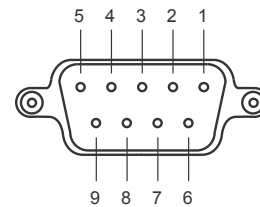

Terminal Block RS-422/485 Pinouts for NPort 5430/5430I

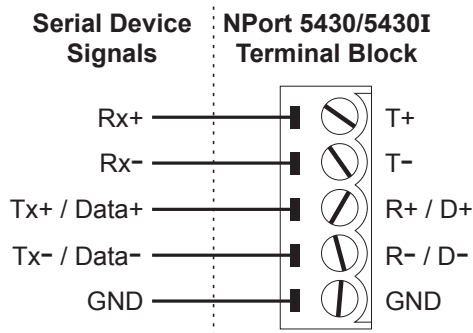

Cable Wiring Diagrams

Ethernet Cables

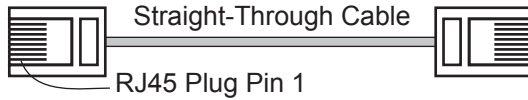

Cable Wiring

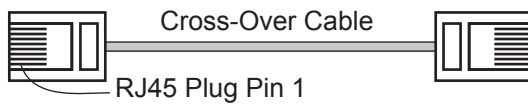
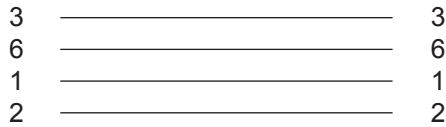

Cable Wiring

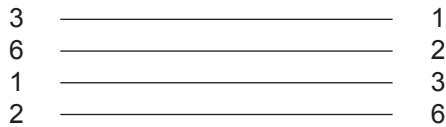

Serial Cables

DB9 Female to DB9 Male for NPort 5410/5450/5450I

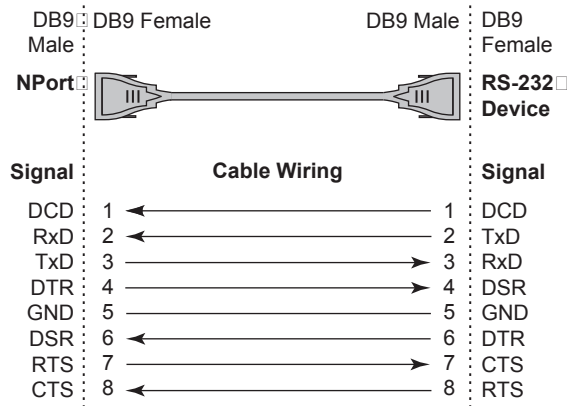

DB9 Female to DB25 Male for NPort 5410/5450/5450I

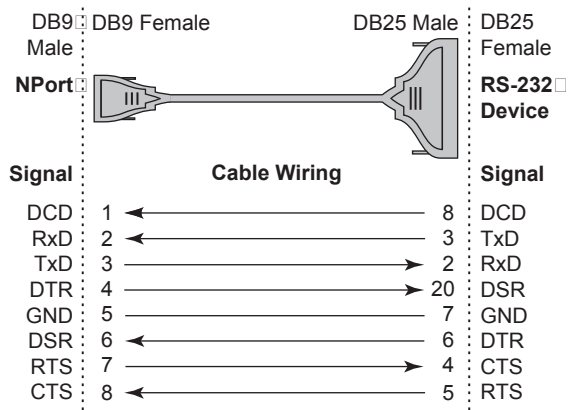

B

Well Known Port Numbers

This appendix is for your reference about the Well Known port numbers that may cause network problem if you set the NPort into the same port. Refer to RFC 1700 for Well Known port numbers of refer to the following introduction from the IANA.

The port numbers are divided into three ranges: the Well Known Ports, the Registered Ports, and the Dynamic and/or Private Ports.

The Well Known Ports are those from 0 through 1023.

The Registered Ports are those from 1024 through 49151.

The Dynamic and/or Private Ports are those from 49152 through 65535.

The Well Known Ports are assigned by the IANA, and on most systems, can only be used by system processes or by programs executed by privileged users. The following table shows famous port numbers among the well-known port numbers. For more details, please visit the IANA website: <http://www.iana.org/assignments/port-numbers>

| TCP Socket | Application Service |
|------------|--------------------------------------|
| 0 | reserved |
| 1 | TCP Port Service Multiplexor |
| 2 | Management Utility |
| 7 | Echo |
| 9 | Discard |
| 11 | Active Users (systat) |
| 13 | Daytime |
| 15 | Netstat |
| 20 | FTP data port |
| 21 | FTP CONTROL port |
| 23 | Telnet |
| 25 | SMTP (Simple Mail Transfer Protocol) |
| 37 | Time (Time Server) |
| 42 | Host name server (names server) |
| 43 | Whois (nickname) |
| 49 | (Login Host Protocol) (Login) |

| TCP Socket | Application Service |
|------------|---------------------------------------|
| 53 | Domain Name Server (domain) |
| 79 | Finger protocol (Finger) |
| 80 | World Wide Web HTTP |
| 119 | Network News Transfer Protocol (NNTP) |
| 123 | Network Time Protocol |
| 213 | IPX |
| 160 – 223 | Reserved for future use |

| UDP Socket | Application Service |
|------------|---------------------------------------|
| 0 | reserved |
| 2 | Management Utility |
| 7 | Echo |
| 9 | Discard |
| 11 | Active Users (sysstat) |
| 13 | Daytime |
| 35 | Any private printer server |
| 39 | Resource Location Protocol |
| 42 | Host name server (names server) |
| 43 | Whois (nickname) |
| 49 | (Login Host Protocol) (Login) |
| 53 | Domain Name Server (domain) |
| 69 | Trivial Transfer Protocol (TETP) |
| 70 | Gopler Protocol |
| 79 | Finger Protocol |
| 80 | World Wide Web HTTP |
| 107 | Remote Telnet Service |
| 111 | Sun Remote Procedure Call (Sunrpc) |
| 119 | Network News Transfer Protocol (NNTP) |
| 123 | Network Time Protocol (nnp) |
| 161 | SNMP (Simple Network Mail Protocol) |
| 162 | SNMP Traps |
| 213 | IPX (Used for IP Tunneling) |

C

SNMP Agents with MIB II & RS-232 Like Group

The NPort 5400 has built-in SNMP (Simple Network Management Protocol) agent software. It supports SNMP Trap, RFC1317 RS-232 like group and RFC 1213 MIB-II. The following table lists the standard MIB-II group, as well as the variable implementation for the NPort 5400.

RFC1213 MIB-II supported SNMP variables:

| System MIB | Interfaces MIB | IP MIB | ICMP MIB |
|-------------------|-----------------------|-------------------|---------------------|
| SysDescr | ifNumber | ipForwarding | IcmpInMsgs |
| SysObjectID | ifIndex | ipDefaultTTL | IcmpInErrors |
| SysUpTime | ifDescr | ipInreceives | IcmpInDestUnreachs |
| SysContact | ifType | ipInHdrErrors | IcmpInTimeExcds |
| SysName | ifMtu | ipInAddrErrors | IcmpInParmProbs |
| SysLocation | ifSpeed | ipForwDatagrams | IcmpInSrcQuenchs |
| SysServices | ifPhysAddress | ipInUnknownProtos | IcmpInRedirects |
| | ifAdminStatus | ipInDiscards | IcmpInEchos |
| | ifOperStatus | ipInDelivers | IcmpInEchoReps |
| | ifLastChange | ipOutRequests | IcmpInTimestamps |
| | ifInOctets | ipOutDiscards | IcmpTimestampReps |
| | ifInUcastPkts | ipOutNoRoutes | IcmpInAddrMasks |
| | ifInNUcastPkts | ipReasmTimeout | IcmpOutMsgs |
| | ifInDiscards | ipReasmReqds | IcmpOutErrors |
| | ifInErrors | ipReasmOKs | IcmpOutDestUnreachs |
| | ifInUnknownProtos | ipReasmFails | IcmpOutTimeExcds |
| | ifOutOctets | ipFragOKs | IcmpOutParmProbs |
| | ifOutUcastPkts | ipFragFails | IcmpOutSrcQuenchs |
| | ifOutNUcastPkts | ipFragCreates | IcmpOutRedirects |
| | ifOutDiscards | ipAdEntAddr | IcmpOutEchos |
| | ifOutErrors | ipAdEntIfIndex | IcmpOutEchoReps |

| System MIB | Interfaces MIB | IP MIB | ICMP MIB |
|-------------|----------------|-------------------------|----------------------|
| SysServices | ifOutQLen | ipAdEntNetMask | IcmpOutTimestamps |
| | ifSpecific | ipAdEntBeastAddr | IcmpOutTimestampReps |
| | | ipAdEntReasmMaxSize | IcmpOutAddrMasks |
| | | IpNetToMediaIfIndex | IcmpOutAddrMaskReps |
| | | IpNetToMediaPhysAddress | |
| | | IpNetToMediaNetAddress | |
| | | IpNetToMediaType | |
| | | IpRoutingDiscards | |

| UDP MIB | TCP MIB | SNMP MIB |
|--------------------------------|---------------------|-------------------------|
| UdpInDatagrams | tcpRtoAlgorithm | snmpInPkts |
| UdpNoPorts | tcpRtoMin | snmpOutPkts |
| UdpInErrors | tcpRtoMax | snmpInBadVersions |
| UdpOutDatagrams | tcpMaxConn | snmpInBadCommunityNames |
| UdpLocalAddress | tcpActiveOpens | snmpInASNParseErrs |
| UdpLocalPort | tcpPassiveOpens | snmpInTooBigs |
| | tcpAttempFails | snmpInNoSuchNames |
| Address Translation MIB | tcpEstabResets | snmpInBadValues |
| AtIfIndex | tcpCurrEstab | snmpInReadOnlys |
| AtPhysAddress | tcpInSegs | snmpInGenErrs |
| AtNetAddress | tcpOutSegs | snmpInTotalReqVars |
| Address Translation MIB | TCP MIB | SNMP MIB |
| AtNetAddress | tcpRetransSegs | snmpInTotalSetVars |
| | tcpConnState | snmpInGetRequests |
| | tcpConnLocalAddress | snmpInGetNexts |
| | tcpConnLocalPort | snmpInSetRequests |
| | tcpConnRemAddress | snmpInGetResponses |
| | tcpConnRemPort | snmpInTraps |
| | tcpInErrs | snmpOutTooBigs |
| | tcpOutRsts | snmpOutNoSuchNames |
| | | snmpOutBadValues |
| | | snmpOutGenErrs |
| | | snmpOutGetRequests |
| | | snmpOutGetNexts |
| | | snmpOutSetRequests |

| Address Translation MIB | TCP MIB | SNMP MIB |
|-------------------------|---------|-----------------------|
| | | snmpOutGetResponses |
| | | snmpOutTraps |
| | | snmpEnableAuthenTraps |

RFC1317: RS-232 MIB objects

| Generic RS-232-like Group | RS-232-like General Port Table | RS-232-like Asynchronous Port Group |
|---------------------------|--------------------------------|-------------------------------------|
| rs232Number | rs232PortTable | rs232AsyncPortTable |
| | rs232PortEntry | rs232AsyncPortEntry |
| | rs232PortIndex | rs232AsyncPortIndex |
| | rs232PortType | rs232AsyncPortBits |
| | rs232PortInSigNumber | rs232AsyncPortStopBits |
| | rs232PortOutSigNumber | rs232AsyncPortParity |
| | rs232PortInSpeed | |
| | rs232PortOutSpeed | |

| The Input Signal Table | The Output Signal Table |
|------------------------|-------------------------|
| rs232InSigTable | rs232OutSigTable |
| rs232InSigEntry | rs232OutSigEntry |
| rs232InSigPortIndex | rs232OutSigPortIndex |
| rs232InSigName | rs232OutSigName |
| rs232InSigState | rs232OutSigState |

D

Auto IP Report Protocol

NPort device servers provide several ways to configure Ethernet IP addresses. One of them is DHCP Client. When you set up the NPort to use DHCP Client to configure Ethernet IP addresses, it will automatically send a DHCP request over the Ethernet to find the DHCP Server. And then the DHCP Server will send an available IP address to the NPort. The NPort will use this IP address for a period of time after receiving it. But the NPort will send a DHCP request again to the DHCP Server. Once the DHCP Server realizes that this IP address is to be released to other DHCP Client, the NPort then will receive a different IP address. For this reason, users sometimes find that the NPort will use different IP addresses, not a fixed IP address.

In order to know what IP address the NPort is using, you need to set up parameters in Network Settings via Web browser. The figure below is the NPort Web console configuration window. Enter the IP address and the Port number of the PC that you want to send this information to.

The screenshot shows the Moxa NPort Web console configuration window. The interface includes a navigation menu on the left and a main configuration area on the right. The main area is titled "Network Settings" and contains several sections: "Network Settings", "SNMP Setting", and "IP Address report". The "IP Address report" section is highlighted with a red oval. The "IP Address report" section contains three fields: "Auto report to IP" (192.168.2.149), "Auto report to TCP port" (4002), and "Auto report period" (10 seconds). A "Submit" button is located at the bottom right of the configuration area.

| Network Settings | |
|-------------------------|---|
| IP address | 192.168.127.254 |
| Netmask | 255.255.0.0 |
| Gateway | 255.255.255.255 |
| IP configuration | DHCP |
| DNS server 1 | |
| DNS server 2 | |
| SNMP Setting | |
| SNMP | <input checked="" type="radio"/> Enable <input type="radio"/> Disable |
| Community name | public |
| Contact | |
| Location | |
| IP Address report | |
| Auto report to IP | 192.168.2.149 |
| Auto report to TCP port | 4002 |
| Auto report period | 10 seconds |

Submit

And then you can develop your own programs to receive this information from the NPort. Here is NPort's Auto IP Report Protocol. We provide an example for you to easily develop your own programs. You can find this example on Moxa's website.

Auto IP Report Format

| | | | | |
|-----------------|---------|---------|-----|---------|
| "Moxa", 4 bytes | Info[0] | Info[1] | ... | Info[n] |
|-----------------|---------|---------|-----|---------|

Info [n]

| Field | ID | Length | Data |
|--------|----|--------|------------------------------------|
| Length | 1 | 1 | Variable, Length is "Length Field" |

ID List

| ID Value | Description | Length | Note |
|----------|------------------|----------|--|
| 1 | Server Name | Variable | ASCII char |
| 2 | Hardware ID | 2 | Little-endian |
| 3 | MAC Address | 6 | 6 bytes MAC address. If the MAC address is "00-90-E8-01-02-03", the MAC [0] is 0, MAC[1] is 0x90(hex), MAC[2] is 0xE8(hex), and so on. |
| 4 | Serial Number | 4, DWORD | Little-endian |
| 5 | IP Address | 4, DWORD | Little-endian |
| 6 | Netmask | 4, DWORD | Little-endian |
| 7 | Default Gateway | 4, DWORD | Little-endian |
| 8 | Firmware Version | 4, DWORD | Little-endian Ver1.3.4= 0x0103040 |
| 9 | AP ID | 4, DWORD | Little-endian |

AP ID & Hardware ID Mapping Table

| AP ID | Hardware ID | Product |
|------------|-------------|----------------|
| 0x80005000 | 0x0504 | NPort 5410 |
| 0x80005000 | 0x0534 | NPort 5430 |
| 0x80005000 | 0x1534 | NPort 5430I |
| 0x80005000 | 0x5401 | NPort 5410 V3 |
| 0x80005000 | 0x5402 | NPort 5430 V3 |
| 0x80005000 | 0x5403 | NPort 5430I V3 |
| 0x80005000 | 0x5404 | NPort 5450 |
| 0x80005000 | 0x5405 | NPort 5450I |
| 0x80005000 | 0x5406 | NPort 5450-T |
| 0x80005000 | 0x5407 | NPort 5450I-T |

Compliance Notice



CE Warning

This is a Class A product. In a domestic environment, this product may cause radio interference in which case the user may be required to take appropriate measures.

Federal Communications Commission Statement

FCC - This device complies with part 15 of the FCC Rules. Operation is subject to the following two conditions: (1) This device may not cause harmful interference, and (2) this device must accept any interference received, including interference that may cause undesired operation.



FCC Warning

This equipment has been tested and found to comply with the limits for a Class A digital device, pursuant to part 15 of the FCC Rules. These limits are designed to provide reasonable protection against harmful interference when the equipment is operated in a commercial environment. This equipment generates, uses, and can radiate radio frequency energy and, if not installed and used in accordance with the instruction manual, may cause harmful interference to radio communications. Operation of this equipment in a residential area is likely to cause harmful interference in which case the user will be required to correct the interference at his own expense.